

# plumbers choice **TRADE ONLY**

# YOU CAN RELY ON US



489 Mountain Highway, Bayswater, VIC 3153  
Email: [info@plumberschoice.com.au](mailto:info@plumberschoice.com.au) • Ph: (03) 9720 8274

[www.plumberschoice.com.au](http://www.plumberschoice.com.au)



# Luke's Editorial



## YOU CAN RELY ON US!

plumbers  
choice **TRADE ONLY**

LUKE BOLTON DIRECTOR, PLUMBERS CHOICE

At Plumbers Choice we never run out of stock! Our centralised warehouses mean that the gear you need is not spread all over the country in 500 far flung locations. Place an order with us and your gear will arrive in full, every time.

We understand premium plumbing systems are an essential part of a modern community. We take our part in the plumber's supply chain seriously and we won't let you down.

If you would like to get the Plumbers Choice Trade Only advantage, maybe now is a great time to give us a try. We understand the importance of high quality plumbing

You may have heard some of these comments from other suppliers.

*"We don't have them on the shelf but I should be able to get some in soon"*

*"You could pick some up from our branch down the road"*

*"We don't have any but let me check the system"*

*"yeh, no problem, about a month to 6 weeks"*

At Plumbers Choice we always have stock. Our centralized warehouses mean that we never run out of stock.

The last couple of years have proven that good plumbing is more essential than ever before. We take pride in assisting you achieve this.

## HOW TO ORDER



### Online - 24 hours

[www.plumberschoice.com.au](http://www.plumberschoice.com.au)



### Email - 24 hours

[sales@plumberschoice.com.au](mailto:sales@plumberschoice.com.au)



### Phone - Business Hours

(03) 9720 8274

Our knowledgeable staff will take your order.



### At our Trade Outlets

Monday - Friday

489 Mountain Highway, Bayswater, VIC 3153

4/200 Woodpark Road, Smithfield, NSW 2164



### Personal Sales Rep

Your personal Sales Representative is able to tailor our service to suit your needs.



Shop  
Trade Only  
from the palm  
of your hand!

# MONUMENT PVC CUTTERS



**QUICK & CLEAN CUT!**



**PIPE CUTTER  
AUTOCUT MONUMENT  
50MM PVC**

**\$53<sup>02</sup>**

INC. GST  
Code: 2645



**PIPE CUTTER  
AUTOCUT MONUMENT  
40MM PVC**

**\$49<sup>72</sup>**

INC. GST  
Code: 2644

**GREAT  
FOR 40MM  
& 50MM  
POLY**

- Quality UK designed and made
- Quick and clean cut
- Light weight
- Ideal for confined spaces
- Spare blades available



**PIPE CUTTER SPARE BLADES**  
For Monument PVC Autocutters Per 5

- Spare blade suits both 40 & 50mm cutters

**\$17<sup>05</sup>**

INC. GST  
Code: 2646

**MONUMENT TOOLS**



# MULTI PURPOSE COVER PLATE

Suitable for Washing Machines & Dishwashers

- Leave a neat finish in the cupboard
  - Covers a hole in the cupboard up to 120mm x 115mm
  - Keeps pests out
  - Fits hot & cold hoses, power cord, Optional outlet hose cap
- Code: 1796**



**STAINLESS STEEL**

67mm

**Flat**  
**1/2" BSP**  
Pack Qty 50  
Code 9154

67mm

**10mm Rise**  
**1/2" BSP**  
Pack Qty 50  
Code 9153

72mm

**16mm Rise**  
**1/2" BSP**  
Pack Qty 10  
Code 1652

72mm

**22mm Rise**  
**1/2" BSP**  
Pack Qty 10  
Code 1653

65mm

**34mm Rise**  
**1/2" BSP**  
Pack Qty 1  
Code 1649

**NEW**

67mm

**10mm Rise**  
**3/4" BSP**  
Pack Qty 10  
Code 1276

67mm

**Flat**  
**1/2" Copper**  
Pack Qty 50  
Code 9539

67mm

**10mm Rise**  
**1/2" Copper**  
Pack Qty 50  
Code 1238



# DISHWASHER COVER PLATES

*"For the professional plumber"*

- Leave a neat finish in the cupboard
- Keeps pests out
- Fits over the solenoid valve

Code: 1792



70mm

**Flat  
3/4" Copper**  
Pack Qty 1  
Code 9045

70mm

**10mm Rise  
3/4" Copper**  
Pack Qty 1  
Code 1226

70mm

**Flat  
1" Copper**  
Pack Qty 1  
Code 9046

97mm

**Flat  
1-1/4" Copper**  
Pack Qty 1  
Code 9047

97mm

**Flat  
1-1/2" Copper**  
Pack Qty 1  
Code 9048

97mm

**Flat  
2" Copper**  
Pack Qty 1  
Code 9049

70mm

**Flat Square  
1/2" BSP**  
Pack Qty 10 Code 4011

STAINLESS STEEL

70mm

**10mm Rise Square  
1/2" BSP  
Chrome Plated**  
Pack Qty 2 Code 4010

CHROME PLATED  
ABS PLASTIC

# Have you had this happen to you?



## We have the Solution!



Hot water unit was here  
\$\$  
☺

### MARCO HOT WATER SECURITY TEMPLATE

Protect your jobs in just 3 Simple steps!

- Rough in pipes to this template
- Foil the thieves
- Reuseable on countless jobs

Pre-drilled template set up for:  
Rinnai 26, Rheem 26 Metro, Thermann 26

Code: 8695



1. Install Template on the wall



2. Connect hot, cold & gas to the frame



3. Fit & commission the unit on hand-over day

**ONLY \$49.50**  
SAVE \$22

# Quickie Kit



Connections to unit allow for height adjustment

Universal swivel fittings for sideways adjustment

Gas valve included 20mm

Kit comes complete with high performance tempering valve



24 Month warranty

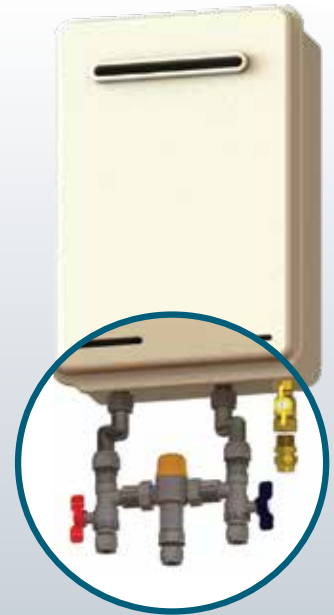

Insulation & cable ties provided to comply with AS3500

**Fit-off a hot water service in minutes!**  
Suits all instantaneous hot water services.

15mm outlet & tempering valve Code: 8300 | 20mm outlet & tempering valve Code: 8301

**Andrew from AMT Plumbing in Bayswater said:**

I recently tried the Quickie Kit on an install. I reckon it saved me at least 30-45 minutes. The insulation and cable ties included in the kit made for a nice neat finish. Everything I needed was there.

## Loose Nut Ball Valve Kit with Union

- Gas 20mm loose nut x 20mm female
- Water 20mm loose nut x 20mm female
- Outlet fitting 20Fi x 20C

Code: 8306



**Instantaneous Continuous Flow Kit**



# SPECIAL

## VALVES



ONLY  
**\$44<sup>00</sup>**  
INC GST



ONLY  
**\$33<sup>00</sup>**  
INC GST

### PTR VALVES

- 2 year warranty
- HT55
- Comes with insulation

1000 kPa **Code: 1626**

1400 kPa **Code: 1628**



### COLD WATER EXPANSION VALVES

- 2 year warranty
- Comes with insulation

1200 kPa **Code: 3604**

850 kPa **Code: 3605**



Valid until April 30th 2022



# LOOSE NUT DUO VALVES

- Watermark approved
- 100% pressure tested
- Integral non-return and isolation function
- Suitable for horizontal and vertical installation



## **DUO VALVE** **LOOSE NUT TO COPPER OLIVE 15mm**

- Working temperature -15°C to 90°C
- Maximum pressure rating 1600 KPa

Code: 6862



## **DUO VALVE** **LOOSE NUT TO FI 15mm**

- Working temperature -15°C to 90°C
- Maximum pressure rating 1600 KPa

Code: 6861



## **DUO VALVE** **LOOSE NUT TO COPPER PUSH FIT 15mm**

- Working temperature -15°C to 90°C
- Maximum pressure rating 1600 KPa

Code: 6863



## **DUO VALVE** **LOOSE NUT TO PRESS 15mm**

- Working temperature -15°C to 90°C
- Maximum pressure rating 1600 KPa

Code: 6860

# STEEL STUDWORK?

plumbers choice

HAS THE ANSWERS!

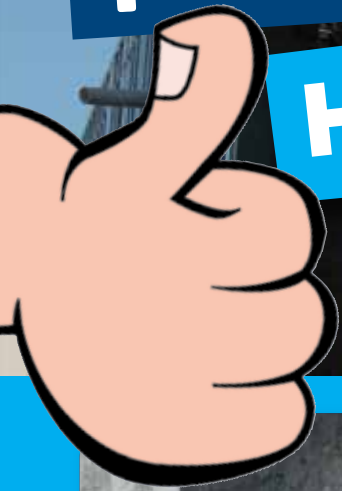

34MM  
AND  
58MM



## STEEL STUD DRILL

- Also great in roofing work for overflows, etc
- 34mm to suit yellow grommets
- 58mm for drainage vents

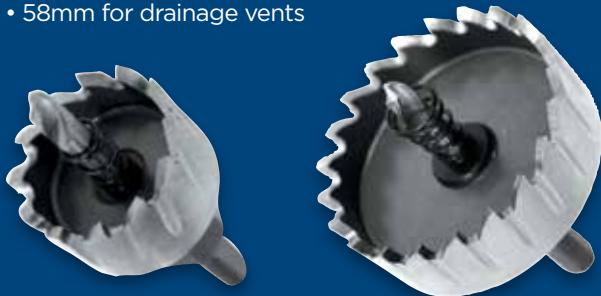

34mm

58mm

**\$70<sup>55</sup>**  
INC. GST  
Code: 2000

**\$152<sup>09</sup>**  
INC. GST  
Code: 2001



## STUD CLIPS - WITH SD SCREW

- Works in any size hole

BAG  
100

16MM  
AND  
20MM



16mm

20mm

**\$29<sup>08</sup>**  
INC. GST  
Code: 5571

**\$30<sup>89</sup>**  
INC. GST  
Code: 5572



**\$599<sup>37</sup>**  
INC. GST  
Code: 1914

**STUD PUNCH**

- For the plumber in a hurry!
- Designed for cutting holes in steel stud work
- Cuts holes super fast



BAG  
100

**\$427<sup>4</sup>**  
INC. GST  
Code: 9241



**MULTI-FIT GROMMET**

Works in varying thicknesses of studwork (thickness 0.42mm to 2mm)  
Complies to Australian Standards AS3500.1 12 Clause 5.5 2.2 Part C



**ONE CLIP FITS 16MM - 20MM PEX PIPE**



BAG  
100



**\$331<sup>9</sup>**  
INC. GST  
Code: 5558

**DUALPEX CLIP SD SCREW**

BAG  
100



**\$355<sup>9</sup>**  
INC. GST  
Code: 5575

**DUALPEX CLIP SD SCREW WITH TAB**

BAG  
100



16mm  
Code: 4526 **\$33.17**  
20mm  
Code: 4527 **\$36.71**

**PEX SADDLES SD SCREW WITH TAB**

**PRELOADED**

WITH HEX SD SCREWS  
Code: 1471



330mm - 600mm

**UNLOADED**

Code: 1450



330mm - 600mm

**MINI PRELOADED**

WITH BUGLE SCREWS  
Code: 1474



190mm - 330mm

**FASTANOG**

- Faster than timber noggins
- Compulsory in termite areas
- Set back measurer



preloaded  
set back  
measurer

**SLIDE TO ADJUST LENGTH**



# Jacko's Review



**plumtest**

## RIGHT ANGLED TEST PLUG

Cannot be lost down a drain

- The only plug to use when testing at a right-angled junction
- 100mm
- Improved design
- Cast aluminium
- No need to put your hand down the drain

Patented

**SPECIAL**

**\$99.00** INC. GST

Code: 2004

**SAVE \$54.16**

Really good tool. Better than using the blow up bulb. Easier to get in and out.  
Andrew J Robertson

A

Use it on every drain. Great handy tool that works well - very happy with it.  
Josh at Inflow Plumbing Solutions

J

Saves me having to put my hand down the drain to tighten. Can't lose it either. Saves time.

K

Ken at Fluidforce Plumbing

**CHS** CHRIS HUNTER SALES

Valid until April 30th 2022



**THE ONLY**  
**FitOff™** tape with  
an **AGA Approval**



**\$284.23**  
INC GST  
**100**  
ROLLS



## Fit Off™ Teflon Tape

Blends in with chrome tapware

Code: 1546 Qty: Box of 100 rolls

## BROADMAN TEFLON TAPE



**NOW ONLY**  
**\$6.60**  
INCLUDING GST  
CODE: 4810



- AGA Approved
- Extra wide grey teflon tape
- 19mm x 30m roll
- Suitable for Potable Water, Natural Gas, Butane & Propane

# RED BACK



# NEED TO TIDY UP SOME WE'VE GOT YOU

## SHOWER MIXER FIXER

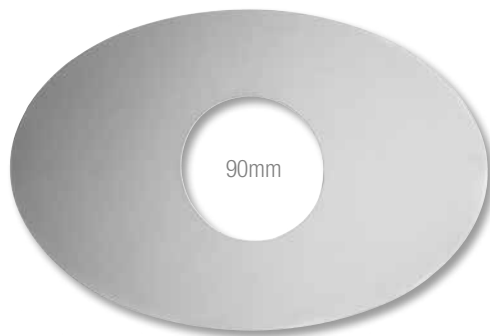

200mm

300mm

### SHOWER MIXER FIXER

- Replace shower mixers with ease
- Fits all mixers
- Chrome plated brass

**\$90.51**

Pack Qty 1

**OVAL** | Code 2987

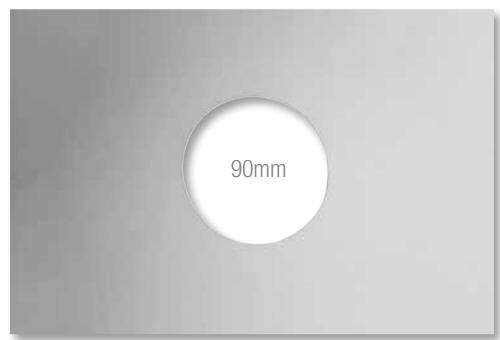

200mm

300mm

### SHOWER MIXER FIXER

- Replace shower mixers with ease
- Fits all mixers
- Chrome plated brass

**\$92.94**

Pack Qty 1

**RECTANGLE** | Code 2983



### SHOWER MIXER FIXER

**Powder coated black metal.  
Professional architectural finish.**

- Replace shower mixers with ease
- Fits all mixers
- 90mm Hole
- 300mm x 200mm

**\$134.82**

Pack Qty 1

**RECTANGLE** | Code 2993

# TILES? COVERED.



## TILER'S BOO BOO

- Chrome plated brass
- For use behind tap flanges



### 90mm Square

Pack Qty 1 | Code 6170 | \$16.79ea

## TILER'S BOO BOO



## TILER'S BOO BOO

- Chrome plated brass
- For use behind tap flanges



### 90mm Round

Pack Qty 1 | Code 4012 | \$15.21ea



## TILER'S BOO BOO

- Powder coated black metal
- Professional architectural finish.

### 90mm Square

Pack Qty 1 | Code 6172 | \$20.32ea

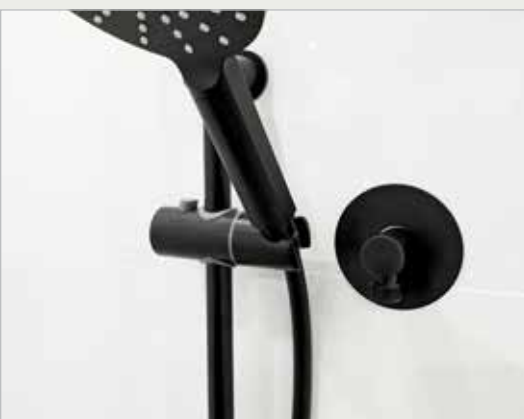

## TILER'S BOO BOO

- Powder coated black metal
- Professional architectural finish.

### 90mm Round

Pack Qty 1 | Code 6173 | \$19.83ea

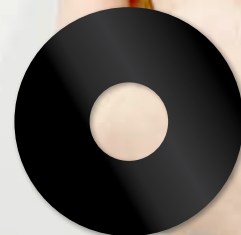

- For a professional finish inside the cupboard.
- Flexy Flange cupboard plate fits tight to pipe which makes it ant-proof.

# 1 Flexy Flange Fits 4 Sizes!



80mm

Suits 9-22mm pipe

**Small**

Pack Qty 10

**\$22.64** INC. GST

Code: 8250

**PATENTED**



90mm

Suits 22-44mm pipe

**Medium**

Pack Qty 5

**\$15.04** INC. GST

Code: 8252

**PATENTED**

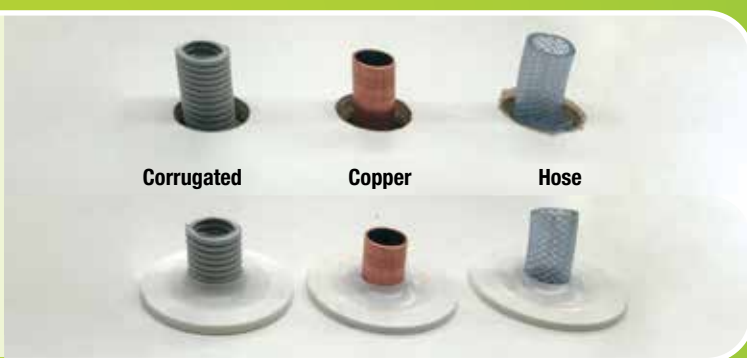

105mm

Suits 40-60mm pipe

**Large**

Pack Qty 5

**\$16.74** INC. GST

Code: 9968

**PATENTED**



115mm

170mm

Suits 40-60mm pipe

**Rectangle**

Pack Qty 5

**\$22.26** INC. GST

Code: 2202

**PATENTED**





# EXTENDO

GAS CONNECTOR

**F + F NOW AVAILABLE**



**BROMIC**  
PLUMBING & GAS

Extendable  
from **650mm**  
to **1200mm**

- ✓ Saves Space, **ONE Connector does it all!**
- ✓ 12mm internal bore for better gas flow
- ✓ Flame resistant stainless steel
- ✓ AGA Approved 8633G
- ✓ 1/2" M+F
- ✓ 1/2" F+F

**HANDY TIP:**  
Attach a brass tee to either end  
to create a handle

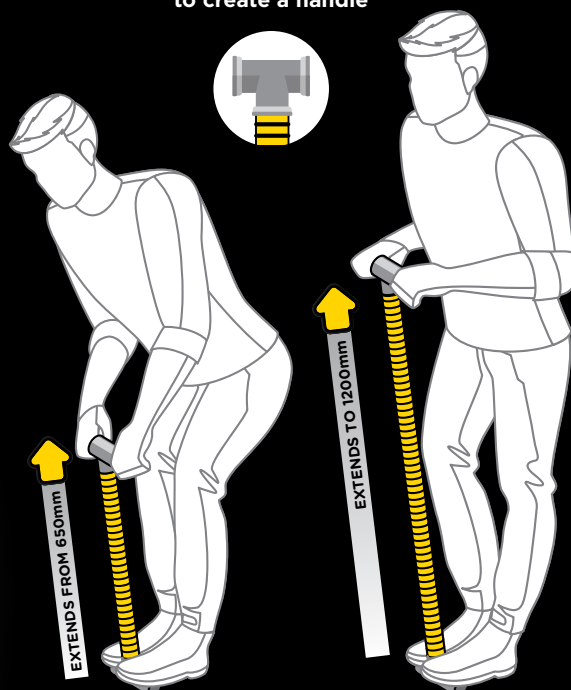

BOX  
10

\$246.<sup>78</sup>  
INC. GST

M+F Code: 6176  
F+F Code: 6178

# GOT A ROOF JOB?

## TURN UP TOOLS



**5**  
CORRUGATIONS  
AT ONCE

### MULTI - HEAD WHALE TOOL

- 2 turn up operations per sheet
- The choice of 2 handle sockets allows for different roof pitches
- Comes with 550mm handle



CORRUGATED



CODE: 6420

\$210.14  
INC. GST



**HEAVY  
DUTY**

### WHALE TOOL

- Fast, lightweight tool for weathering corrugated sheets
- Fits in nail bag



CORRUGATED



CODE: 6421

\$73.74  
INC. GST



**THE  
FASTEST  
TURN UP TOOL  
FOR TRAY DECK  
ROOFING**

### HINGED TURN UP TOOL 185MM

- Hinged design opens wide for fast application
- The perfect height turn up every time
- 185mm head



200MM DECK



CODE: 9864

\$158.52  
INC. GST



**NEED THE RIGHT TOOL  
FOR A DECKING ROOF?**

### TURN UP TOOL

#### KIT CONTAINS:

- 4 Interchangeable heads
- 2 x 550mm handles
- 1 x 250mm handle
- Turn up and turn down attachment for 150mm decks
- Turn up and turn down attachment for 200mm decks
- Sturdy PVC storage container



150MM DECK



200MM DECK



CODE: 1754

\$280.60  
INC. GST

# WE'VE GOT YOU COVERED!

## BENDING PLIERS



**STRAIGHT SPRING  
LOADED 80MM**

**CODE: 2422** \$104.<sup>58</sup>  
INC. GST



**R/A SPRING  
LOADED 80MM**

**CODE: 2423** \$111.<sup>64</sup>  
INC. GST



**STRAIGHT SPRING  
LOADED 150MM**

**CODE: 9842** \$146.<sup>89</sup>  
INC. GST



**STRAIGHT**

- All steel forged construction
- 220mm long

**CODE: 9352** \$82.<sup>26</sup>  
INC. GST



**CURVED 45 DEGREE**

- All steel forged construction
- 220mm long

**CODE: 2425** \$82.<sup>26</sup>  
INC. GST



**CURVED 90 DEGREE**

- All steel forged construction
- 220mm long

**CODE: 2424** \$82.<sup>26</sup>  
INC. GST



# TAPW



## WALL SINK SET

Code: 3703 \$100.67 (INC. GST)



## HOB SINK SET

Code: 3706 \$110.96 (INC. GST)



## BASIN SET

Code: 3700 \$94.31 (INC. GST)

Code: 3699 Ceramic Disc \$143.59 (INC. GST)



## BATH SET

Code: 3701 \$59.21 (INC. GST)



## BASIN TOP ASSEMBLIES

Code: 3707 \$41.71 (INC. GST)

Code: 3712 Ceramic Disc \$78.65 (INC. GST)



## WALL TOP ASSEMBLIES

Code: 3704 \$41.71 (INC. GST)

Code: 3710 Ceramic Disc \$78.65 (INC. GST)



## SWIVEL SPOUT WALL TUBE C/P 180mm

Code: 7095 \$29.55 (INC. GST)



## SWIVEL SPOUT HOB TUBE C/P 180mm

Code: 7096 \$21.98 (INC. GST)



## LAUNDRY ARM SWIVEL C/P 150mm

Code: 3711 \$12.86 (INC. GST)

# ARE

# CHROME PLATED FINISH



### SHOWER SET

Code: 3702 \$65.14 (INC. GST)



### BOOSTER HANDLES & BUTTONS

Code: HD09 \$6.33 (INC. GST)



### SHOWER ROSE UNIVERSAL ALL DIRECTIONAL

Code: SH02 \$22.41 (INC. GST)

Code: SH02SW Loose Nut \$25.63 (INC. GST)



### TOP ASSEMBLIES RECESSED 15mm

Code: 7500 \$17.52 (INC. GST)



### WASHING MACHINE CONVERSION UNIT UNIVERSAL

Code: WMC \$174.58 (INC. GST)



### WASHING MACHINE SET

Code: 3705 \$50.59 (INC. GST)

# NEW



### WALL TOP ASSEMBLY LEVER HANDLE EZ CLEAN ANTI-VANDAL

Code: 3714 \$112.27 (INC. GST)



### BASIN TOP ASSEMBLY LEVER HANDLE EZ CLEAN ANTI-VANDAL

Code: 3720 \$112.27 (INC. GST)



### BASIN SET LEVER HANDLE EZ CLEAN ANTI-VANDAL

Code: 3737 \$176.22 (INC. GST)



### PILLAR TOP ASSEMBLY EZ CLEAN ANTI-VANDAL

Code: 3730 \$52.21 (INC. GST)

**NEW**

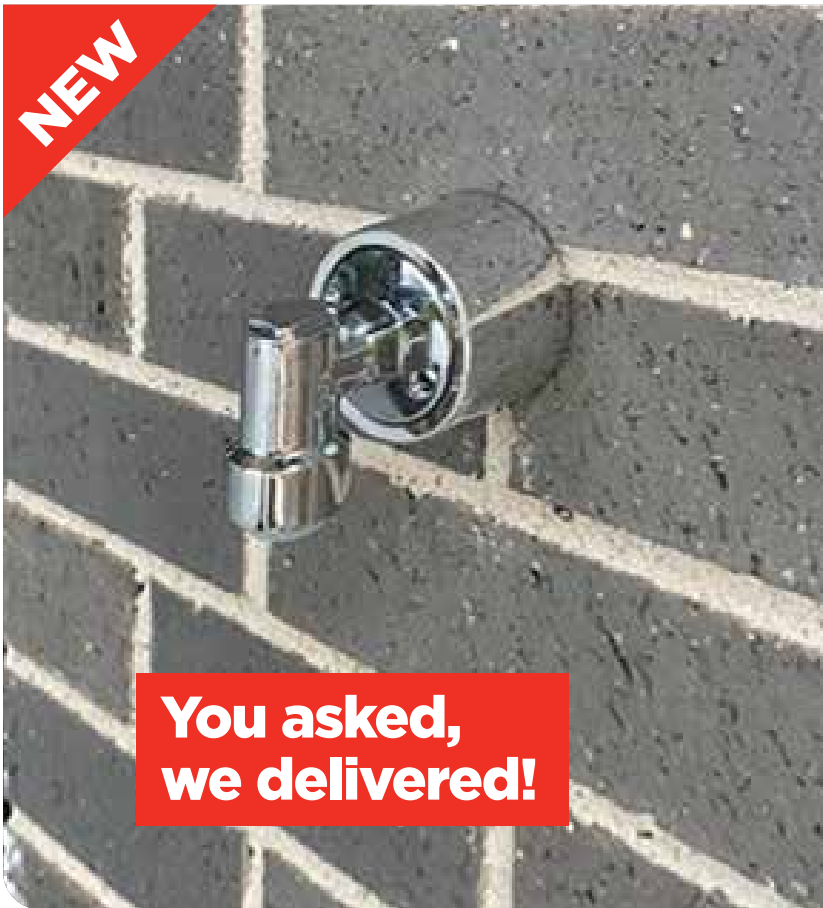

**You asked,  
we delivered!**

## **Cover Plate for Bayonet Fitting**

Code 6599

- The largest rise cover plate on the market.
- 39mm rise
- 1/2 inch BSP
- Ideal for bayonet gas fittings
- Fixing holes line up with bayonet



**NEW**



## **Rough Brass for Corrugated 1/2" BSP**

Code 4005

- Foam backing moulds to any position on corrugate, Keeps bugs out
- Rough brass cover plate matches the hose bib to leave a professional finish
- Will not rust outdoors



**NEW**

Same price as a traditional luggie!

**BLOCK HEAD**



## BLOCKHEAD LUGGED ELBOW

- Reduce the number of noggins required
- Can press it while in place
- Fix it from any direction
- Lead free brass
- 25 year warranty



**PATENTED**

**I hate cutting noggins, what's not to like?**

Tim - Jonesy's Plumbing

**Finally a luggie that can be pressed when screwed in place**

Matt - MWP & E

Blockhead Press  
Water Elbow Lugged  
15mm x 15MI (90mm)  
**Code: 8699**

Blockhead Press  
Gas Elbow Lugged  
15mm x 15MI (90mm)  
**Code: 8698**



### Traditional Fix

Plumber's Noggin



### Stud Fix

Fix to side of studs



### Existing Noggin

Fix to carpenter's noggin

**BRASSHARDS**

EST. 1967



| PLUMBING SUPPLIES SPECIALIST |

Under licence no. 2001



## PRESS GAS FITTINGS



**PRESS GAS COUPLING**

CODE	SIZE	PRICE
8639	15mm	\$6.26
8640	20mm	\$8.04
8641	25mm	\$13.75



**PRESS GAS SLIP REPAIR COUPLING**

CODE	SIZE	PRICE
8642	15mm	\$6.00
8643	20mm	\$7.54
8644	25mm	\$11.69



**PRESS GAS ELBOW F/F 90°**

CODE	SIZE	PRICE
8645	15mm x 90	\$7.44
8646	20mm x 90	\$9.72
8647	25mm x 90	\$17.86



**PRESS GAS ELBOW F/F 45°**

CODE	SIZE	PRICE
8648	20mm x 45	\$11.60
8649	25mm x 45	\$15.46



**PRESS GAS REDUCING COUPLING F/F**

CODE	SIZE	PRICE
8650	20mm x 15mm	\$11.11
8651	25mm x 20mm	\$13.70



**PRESS GAS REDUCER M/F**

CODE	SIZE	PRICE
8652	20mm x 15mm	\$9.71
8653	25mm x 20mm	\$13.12



**PRESS GAS TEE**

CODE	SIZE	PRICE
8654	15mm	\$8.59
8655	20mm	\$14.81
8656	25mm	\$23.15



**PRESS GAS TEE REDUCING**

CODE	SIZE	PRICE
8657	20 x 20 x 15	\$15.29
8658	25 x 25 x 15	\$23.52
8659	25 x 25 x 20	\$26.00



**PRESS GAS END CAP**

CODE	SIZE	PRICE
8660	15mm	\$8.10
8661	20mm	\$9.13
8662	25mm	\$16.08



**PRESS GAS ELBOW LUGGED**

CODE	SIZE	PRICE
8663	15mm x 15FI	\$18.40
8664	20mm x 20FI	\$20.12



**BLOCKHEAD PRESS GAS ELBOW LUGGED (90MM)**

CODE	SIZE	PRICE
8698	15mm x 15MI	\$18.40



**PRESS GAS ADAPTOR MI**

CODE	SIZE	PRICE
8666	15mm x 15MI	\$5.51
8667	20mm x 20MI	\$13.59
8668	25mm x 25MI	\$21.39



**PRESS GAS ADAPTOR FI**

CODE	SIZE	PRICE
8669	15mm x 15FI	\$7.44
8670	20mm x 20FI	\$11.32
8671	25mm x 25FI	\$15.43

## 25 YEAR WARRANTY\*

Brasshards is proud to offer a 25 year warranty against defects and manufacturing faults in CuPress fittings (when installed in accordance with national, state and local plumbing codes by a licensed plumber). Issues arising from incorrect installation, misuse or environmental elements are not covered by this warranty. Please contact Brasshards for a copy of our full warranty document.



# PRESS WATER FITTINGS



**PRESS WATER COUPLING**

CODE	SIZE	PRICE
8601	15mm	\$4.14
8602	20mm	\$6.13
8603	25mm	\$8.70



**PRESS WATER SLIP REPAIR COUPLING**

CODE	SIZE	PRICE
8604	15mm	\$4.69
8605	20mm	\$6.95
8606	25mm	\$10.52



**PRESS WATER ELBOW F/F 90°**

CODE	SIZE	PRICE
8607	15mm x 90	\$4.69
8608	20mm x 90	\$7.18
8609	25mm x 90	\$13.24



**PRESS WATER ELBOW F/F 45°**

CODE	SIZE	PRICE
8610	15mm x 45	\$5.86
8611	20mm x 45	\$8.08
8612	25mm x 45	\$14.87



**PRESS WATER ELBOW M/F 90°**

CODE	SIZE	PRICE
8681	15mm	\$5.41
8682	20mm	\$7.11



**PRESS WATER REDUCING COUPLING F/F**

CODE	SIZE	PRICE
8613	20mm x 15mm	\$9.38
8614	25mm x 20mm	\$15.99



**PRESS WATER REDUCER M/F**

CODE	SIZE	PRICE
8615	20mm x 15mm	\$8.41
8616	25mm x 20mm	\$11.94



**PRESS WATER END CAP**

CODE	SIZE	PRICE
8623	15mm	\$7.43
8624	20mm	\$9.00
8625	25mm	\$17.63



**PRESS WATER TEE**

CODE	SIZE	PRICE
8617	15mm	\$7.23
8618	20mm	\$10.90
8619	25mm	\$20.21



**PRESS WATER TEE REDUCING**

CODE	SIZE	PRICE
8620	20 x 20 x 15	\$13.51
8621	25 x 25 x 15	\$19.12
8622	25 x 25 x 20	\$22.96
8683	20 x 15 x 15	\$17.84
8684	20 x 15 x 20	\$18.77



**PRESS WATER ELBOW LUGGED**

CODE	SIZE	PRICE
8626	15mm x 15FI	\$13.36
8627	20mm x 20FI	\$19.05



**BLOCKHEAD PRESS WATER ELBOW LUGGED (90MM)**

CODE	SIZE	PRICE
8699	15mm x 15MI	\$16.35



**PRESS WATER ELBOW FI**

CODE	SIZE	PRICE
8629	15mm x 15FI	\$14.77
8630	20mm x 20FI	\$17.88



**PRESS WATER ELBOW MI**

CODE	SIZE	PRICE
8631	15mm x 15MI	\$14.23
8632	20mm x 20MI	\$17.89



**PRESS WATER ELBOW UNION**

CODE	SIZE	PRICE
8687	15mm x 1/2"	\$9.03
8688	20mm x 3/4"	\$13.64



**PRESS WATER ADAPTOR MI**

CODE	SIZE	PRICE
8633	15mm x 15MI	\$6.94
8680	15mm x 20MI	\$10.60
8634	20mm x 20MI	\$11.47
8635	25mm x 25MI	\$20.52



**PRESS WATER ADAPTOR FI**

CODE	SIZE	PRICE
8636	15mm x 15FI	\$6.59
8637	20mm x 20FI	\$8.41
8638	25mm x 25FI	\$14.99



**PRESS UNION**

CODE	SIZE	PRICE
8685	Loose Nut 15mm x 15mm Press (Flat Seat)	\$11.61
	Loose Nut 20mm x 20mm Press (Flat Seat)	
8679	Loose Nut Compression 20mm x 20mm Press (Flat Seat)	\$11.75
8689	Loose Nut 20mm x 20mm Press (Flat Seat)	\$10.54

- Flame-free
- Permanent V-Profile press join
- All fittings comply with Australian Standards AS3688





**HUGE SAVINGS!**



## DUAL APPROVED BALL VALVES

### F X F 15MM

- Dual Approved water & gas
- 1/2 inch BSP
- Stainless steel handle & nut

code: 8200

NOW  
**\$6.60**

### F X F 20MM

- Dual Approved water & gas
- 3/4 inch BSP
- Stainless steel handle & nut

code: 8201

NOW  
**\$8.80**

### F X F 25MM

- Dual Approved water & gas
- 1 inch BSP
- Stainless steel handle & nut

code: 8202

NOW  
**\$17.60**

### F X F 32MM

- Dual Approved water & gas
- 1 1/4 inch BSP
- Stainless steel handle & nut

code: 8210

NOW  
**\$27.50**

### F X F 40MM

- Dual Approved water & gas
- 1 1/2 inch BSP
- Stainless steel handle & nut

code: 8211

NOW  
**\$38.50**

### F X F 50MM

- Dual Approved water & gas
- 2 inch BSP
- Stainless steel handle & nut

code: 8212

NOW  
**\$61.60**

Valid until April 30th 2022. All prices inc. GST

# SPECIAL



ONLY  
**\$82.50**

INC GST

Includes  
Low Level  
Flush Pipe

## FLUIDMASTER PRO CISTERN

**Most Powerful Flush System**

**Adjustable up to 9/4.5L PRO Cistern  
with Link and Seat**

- 4.5/3L Dual Flush Technology
  - Simple Flush Volume Conversion to 6/3L or 9/4.5L
  - UV Resistant - Certified
  - Plastic Cistern with Bottom Inlet
  - Saves Water
- INSTALL WITH CONFIDENCE**



Valid until April 30th 2022

# REPAIR CLAMPS

## INTRODUCING

### REPAIR CLAMP FOR COPPER 15mm

- Stainless Steel Band Simple to install
- Suits 1/2 inch copper
- Made from 316 stainless steel
- Full circle nitrile rubber gasket
- Pressure rating of 1600kPa
- Approved for use in potable water supply



Code: 5060

### REPAIR CLAMP FOR COPPER 20mm

- Stainless Steel Band Simple to install
- Suits 3/4 inch copper
- Made from 316 stainless steel
- Full circle nitrile rubber gasket
- Pressure rating of 1600kPa
- Approved for use in potable water supply



Code: 5061

### REPAIR CLAMP FOR COPPER 25mm

- Stainless Steel Band Simple to install
- Suits 1 inch copper
- Made from 316 stainless steel
- Full circle nitrile rubber gasket
- Pressure rating of 1600kPa
- Approved for use in potable water supply



Code: 5062

### REPAIR CLAMP FOR COPPER 32mm

- Stainless Steel Band Simple to install
- Suit 1 1/4 inch copper
- Made from 316 stainless steel
- Full circle nitrile rubber gasket
- Pressure rating of 1600kPa
- Approved for use in potable water supply



Code: 5063

### REPAIR CLAMP FOR GAL PIPE 20mm

- Stainless Steel Band simple to install
- Suits 3/4 inch galvanised pipe
- Made from 316 stainless steel
- Full circle nitrile rubber gasket
- Pressure rating of 1600kPa
- Approved for use in potable water supply



Code: 5064

### REPAIR CLAMP FOR GAL PIPE 25mm

- Stainless Steel Band simple to install
- Suits 1 inch galvanised pipe
- Made from 316 stainless steel
- Full circle nitrile rubber gasket
- Pressure rating of 1600kPa
- Approved for use in potable water supply



Code: 5065

# Drainla®

For use on pipework passing through concrete footings

## DOES YOUR JOB COMPLY?



### DON'T GET CAUGHT OUT!

Drainlag complies with AS1345-1995 (Table 1) indicating that pipes containing sewerage and organic waste should be marked black.

### Drainlag Black

- 100mm x 10 Metre Roll
- Closed Cell
- Non-Absorbant
- Simple to apply to pipe and or fittings
- Complies with the following standards:

#### AS3500 3.8.2 (b)

*"Shall be installed with not less than 25mm annular space"*

#### AS 1345-1995 (Table 1)

*Colour Identification for Sewerage & Organic waste: Black*

#### AS2870 5.5.4 (a)

*"Closed cell polyethylene lagging shall be used around all drainage pipes through external footings"*

Code: 8720

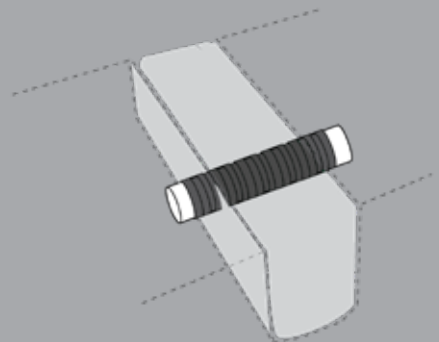
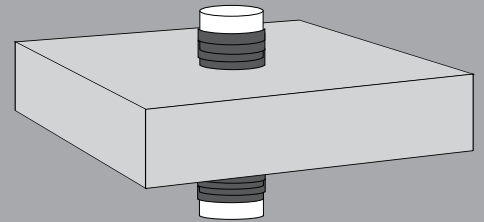

ECO  
FRIENDLY  
PACKAGING

**CHS** CHRIS HUNTER  
SALES

MADE  
FROM  
RECYCLED  
MATERIALS

# WOMBAT

Australian Designed

Brass Shroud prevents spreading and splitting

Tough NP3 compound which is heat resistant and hard wearing

Passes 100,000 cycle test

Complies with AS3718

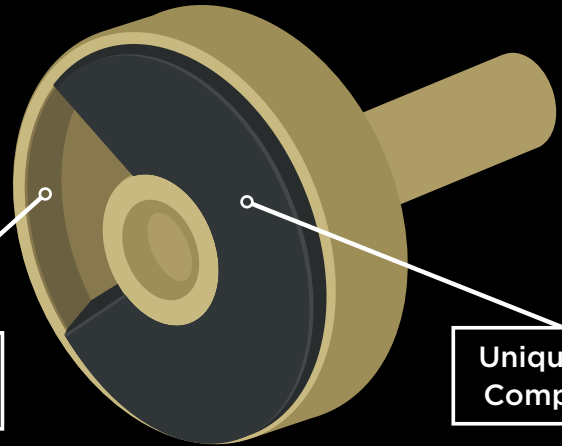

Protective Brass Shroud

Unique NP3 Compound

**10 Pack**  
Code: 8810

**100 Pack**  
Code: 8811

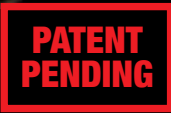

**PLUMTOOL  
BREECH STRAIGHTENER**

- For straightening tap breeches prior to fit off
- Reverse tool to straighten 1/2 B.S.P. lugged elbows
- Patented

Code: 2395      \$63.07 INC.GST

**PLUMTOOL  
TAP FLANGE REMOVER**

- Use with your hand to increase grip x 3
- Grips any shaped flange
- Use very carefully with round jaw multi-grips to remove stubborn flanges
- Be sure to grab the rubber on the flap area

Code: 8539      \$18.47 INC.GST

**PLUMTOOL  
LONG NOSE PLIERS**

- 270mm long, twice the reach of standard pliers
- Will remove tap washers from even the deepest breeches
- Thin profile to fit into tap bodies

Code: 1667      \$45.05 INC.GST



**PLUMTOOL  
FRANZ NUT  
SPINDLE CLEANER**

- For cleaning threads on standard tap spindles
- Much cleaner and easier to use than a wire brush.

Code: 9854      **\$44.99**  
INC. GST



**PLUMTOOL  
FRANZ BONNET CLEANER  
T HANDLE**

- For cleaning and straightening the internal thread of tap spindles

Code: 2006      **\$36.66**  
INC. GST



**RED BACK  
TAP LUBRICANT**

- Working range of between -10°C and 150°C
- Approved for potable water
- 70 gram

Code: 9996      **\$18.08**  
INC. GST

**BODY  
WASHERS  
RED FIBRE  
EZ CLEAN**



- For standard taps
- Thin washer for installation of bells
- 23mm ID x 28 OD

Code: 9449      **\$15.44**  
INC. GST  
Bag of 50

**O RINGS NO.8.5**



- For standard tap repairs
- Number 8.5

Code: 9164      **\$15.15**  
INC. GST  
Bag of 100



**TAP RESEATER -  
FACE & EDGE CUTTER**

- Removes sharp edges on seats so valves will not stick or tear
- Can be used by hand or with battery drill
- Australian designed, made and owned

Code: 2359      **\$91.81**  
INC. GST



**PLUMTOOL  
SPINDLE ACCESS DRILL**

- Cuts tiles to allow access to tap body
- Diamond core drill will cut even the hardest of porcelain tiles
- Nylon bush prevents damage to the spindle
- Patented

Code: 1916      **\$193.45**  
INC. GST



**STRONGEST  
ON MARKET**

**PLUMTOOL  
TUBE SPANNER KIT**

- Will not round out under stress
- Kit Contains:  
Hex 20mm x 21mm,  
Hex 22mm x 23mm,  
Hex 29mm x Square 24mm,  
Hex 25mm & Hex 28mm,  
Turning Bar 230mm
- Made in Germany

Code: 2513      **\$191.44**  
INC. GST



**PLUMTOOL  
TAP HANDLE PULLER**

- Unique shroud stops slipping
- Holes in arms allow for removal of ezy clean handles
- A must for maintenance plumbers

Code: 1758      **\$72.44**  
INC. GST

# NIPPLE CUTTER & CATCHER

- Single piece shaft results in less chattering
- Provides the perfect sealing surface
- Create a flat or chamfered end on the nipple



\$106<sup>51</sup>  
INC. GST

CODE: 9231

**NEW CLEAR CATCHER  
TO SEE HOW FAR YOU  
HAVE TO CUT**



## TO CREATE THE PERFECT SEALING SURFACE:

### STEP 1

Fit the nipple cutter into the clear catcher so that the flat cutting blade is facing the nipple.

### STEP 2

Cut the nipple to length using the flat blade.

### STEP 3

If required, reverse the tool in the drill. Using the angled blade, cut a chamfer on the nipple.

# PIPE CUTTER INTERNAL WITH DIAMOND WHEEL

- Will cut pipe from 40mm up to 150mm
- Fits into a battery drill for easy use
- Diamond wheel will not blunt on concrete or tiles
- Extension Bar available to allow cutting at greater depths
- The safe way to cut PVC when close to tiles or brick work

\$46<sup>16</sup>  
INC. GST

CODE: 1347

**BRILLIANT  
TOOL FOR  
CUTTING  
PVC PIPE**

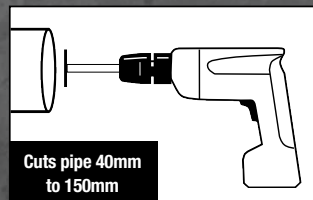

Cuts pipe 40mm  
to 150mm

**plumtool™**

*Innovative tools for* **PLUMBERS**



# YOU SPOKE, WE LISTENED!

To continue to make things easier for you to support Trade Only, we've made a few additions to [www.plumberschoice.com.au](http://www.plumberschoice.com.au)



ORDER TEMPLATES

## Save Order Templates

You can now save custom Order Templates.

With just one click, add all the items from your Order Template to your shopping cart. Perfect for fit off packs, hottie kits or end of month stock top ups.



FAVOURITES

## Favourite Items

Access to your favourite and most used items on the one page.

No more scrolling through to add the same items you buy every order. Now add them all from the convenience of one page.



QUOTES

## Request a Quote

Want some gear quoted?

Haven't had some items priced up by your Sales Rep yet? Well, from the cart page you can now order or request a quote on the gear in your shopping cart.

## Don't have an online account yet?

Head to [www.plumberschoice.com.au/register/](http://www.plumberschoice.com.au/register/) and sign up today. Order any time from the convenience of your phone or laptop.



TIP OF  
THE  
MONTH



We'll tip  
**YOU**  
when you tip  
**US!**



Every featured story receives a  
**\$200 Store Credit**

When installing a back to wall toilet suite and you don't need to install the fixing brackets (Secured with a bead of silicone) you can install the screw fixing covers into the plugs that come with the toilet suite and the plugs fit securely into the holes of the pan and then just clip the chrome cap on and job done.

Courtesy;  
Luke - Midnight  
Plumbing



Thanks to Luke - Midnight Plumbing  
\$200 store credit is coming your way

To get involved send us an email [info@plumberschoice.com.au](mailto:info@plumberschoice.com.au)

# UV STABILISED BLACK NYLON TAP-INS WILL NOT FAIL!



**Weather affected Nylon Tap-Ins are a thing of the past!**

Will not fail when exposed to the sun

Decero coated nails will not rust  
(exceeds 1000 hour salt spray test)



**BOX  
500**



**NYLON TAP-INS  
- UV BLACK**

- For outdoor use
- Black Nylon UV stabilised will not perish

CODE	LENGTH	QTY	PRICE
9524	5mm x 25mm	500	\$81.76
1187	5mm x 40mm	500	\$ 114.41

**BOX  
100**

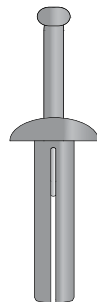

**METAL TAP-INS  
- MUSHROOM HEAD**

- Strong cast alloy

CODE	LENGTH	QTY	PRICE
9387	5mm x 25mm	100	\$34.46
1967	6.5mm x 25mm	100	\$43.81
1968	6.5mm x 32mm	100	\$46.72
1705	6.5mm x 40mm	100	\$49.51

**BOX  
100**

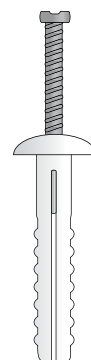

**NYLON TAP-INS  
- MUSHROOM HEAD**

- 100% nylon, not plastic

CODE	LENGTH	QTY	PRICE
9345	5mm x 25mm	100	\$15.09
9925	6.5mm x 50mm	100	\$20.90

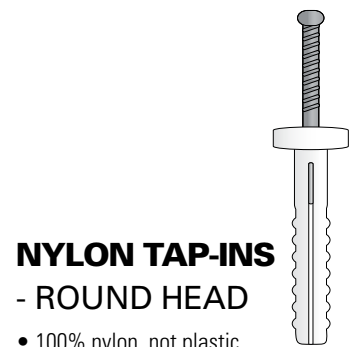

**NYLON TAP-INS  
- ROUND HEAD**

- 100% nylon, not plastic

CODE	LENGTH	QTY	PRICE
9978	5mm x 25mm	100	\$14.78
9907	5mm x 25mm	500	\$65.24
9179	5mm x 40mm	100	\$21.14
9973	5mm x 40mm	500	\$90.51
9567	6.5mm x 25mm	100	\$15.35
2262	6.5mm x 40mm	100	\$22.07

\*All prices include GST

**NEW!**



**PATENTED**

# BAL RATED DRAINAGE VENT & FLASHING KIT

## Kit includes:

- Steel vent and cowl
- BAL rated flashing to suit steel roof
- Steel to PVC insulated adaptor

**BAL12.5**  
Black Flashing Kit

Code: **8876**



**BAL29**  
Red Silicone Kit

Code: **8877**

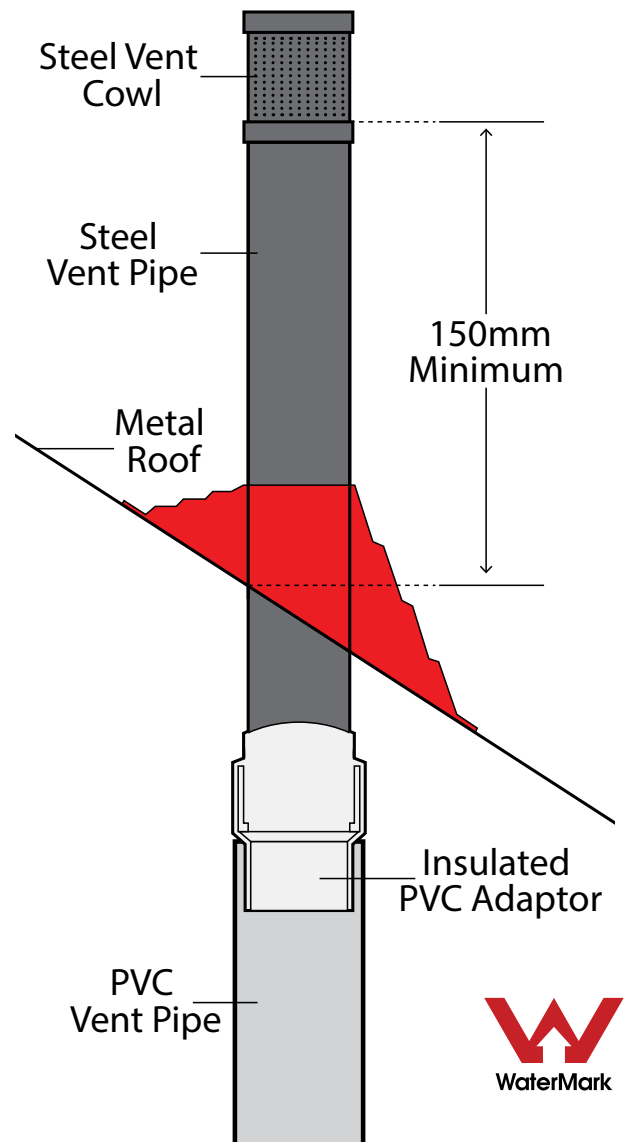

plumtool™

# TIGHTEN BASIN & SINK MIXERS FAST

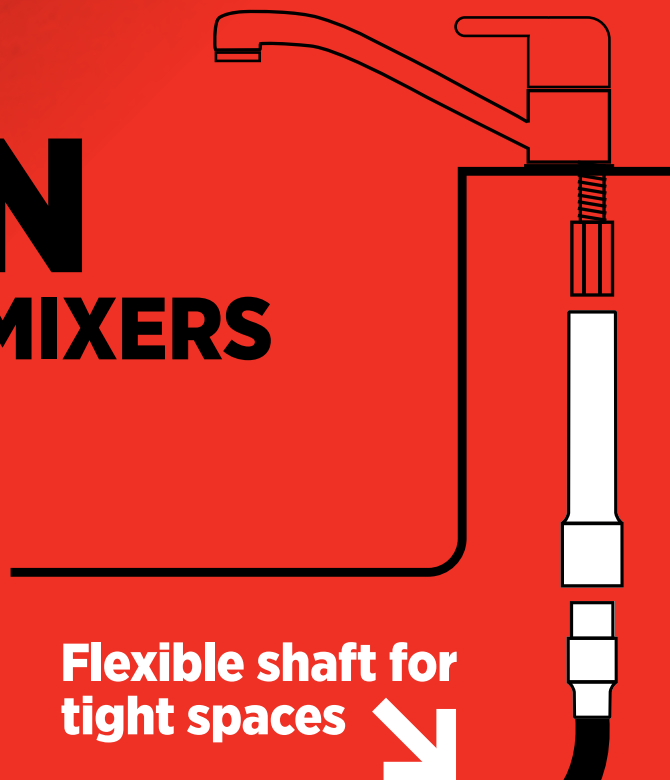

Flexible shaft for  
tight spaces ↘

**IDEAL  
FOR TIGHT  
SPACES**

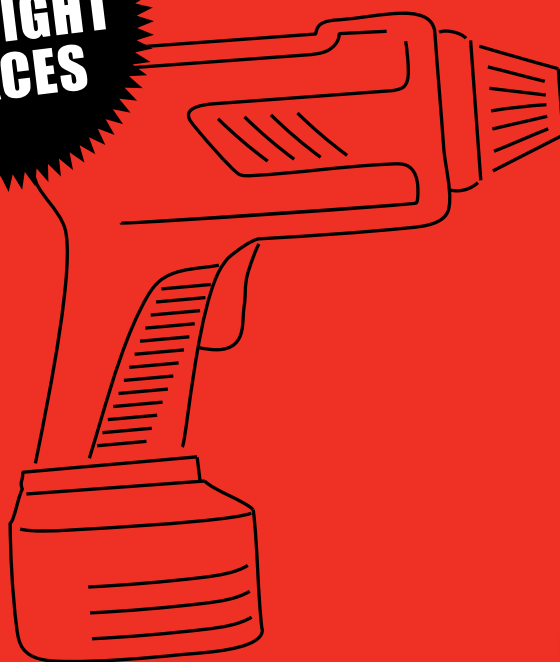

**Extra long  
sockets (120mm)**

## FLEXIBLE MIXER TAP DRIVER KIT

### Kit Contains:

- 3/8 Flexible Drive (200mm long)
- 3/8 Hex Adaptor (40mm long)
- 3/8 Drive Socket Set:  
9mm x 120mm, 10mm x 120mm,  
11mm x 120mm, 12mm x 120mm,  
13mm x 120mm



**\$119.20**  
INC. GST

Code: 9828