

plumbers choice **TRADE ONLY**



489 Mountain Highway, Bayswater, VIC 3153
Email: info@plumberschoice.com.au • Ph: (03) 9720 8274

www.plumberschoice.com.au





PLUMBERS CHOICE DECLARES WAR ON DELIVERY CHARGES!

At Plumbers Choice we know how annoying delivery charges are. That's why our standard delivery will never cost you anything. You only need to spend \$100 to get free delivery anywhere in Australia. That is the lowest in our industry.

There has never been a better time to invest in your own trade and buy Trade Only.

LUKE BOLTON
DIRECTOR, PLUMBERS CHOICE

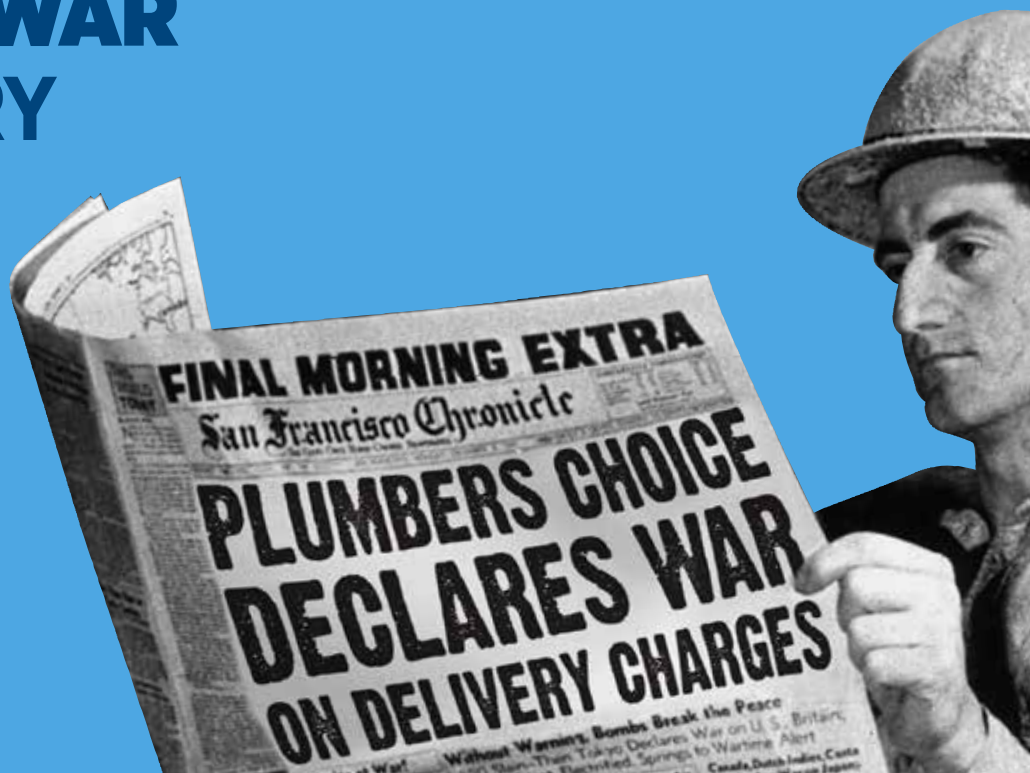

HOW TO ORDER



Online - 24 hours
www.plumberschoice.com.au



Email - 24 hours
sales@plumberschoice.com.au



Phone - Business Hours
(03) 9720 8274
Our knowledgeable staff will take your order.



At our Trade Outlets
Monday - Friday
489 Mountain Highway, Bayswater, VIC 3153
4/200 Woodpark Road, Smithfield, NSW 2164



Personal Sales Rep
Your personal Sales Representative is able to tailor our service to suit your needs.



**Shop
Trade Only
from the palm
of your hand!**

INFLATABLE TEST PLUG 100MM

- Equipped with 2.5m hose
- To suit 100mm PVC
- Inflate with car pump
- Can be used down an inspection shaft

Code: 2009

\$105.67

Equipped with 2.5m hose

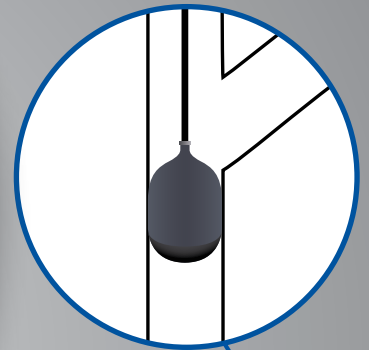

TEST PLUG ALUMINIUM 100MM

- A breeze to install
- 2 convenient tie-off points
- Size 100mm

Code: 2149

\$52.84



TEST PLUG RIGHT ANGLED WITH HANDLES 100mm

- Keeps hands out of the drain
- A breeze to install
- Cannot be lost down drain
- The only plug to use when testing at a right angled junction
- Cast Aluminium
- Patented

Code: 2004

\$153.16





RED BACK SILICONE CLEAN UP

Wipes silicone clean away!



- Specially designed for removing uncured silicone from laminates, porcelain, steel roofing & gutters

\$24.⁰⁷_{INC. GST}
Code: 9997

500ml



TRUSTED PRODUCT
FOR OVER 20 YEARS

AQUARIUS
DISTRIBUTION



HIGH PERFORMANCE FLEXIBLE MS SEALANT AND ADHESIVE

GREY Code: 8225 • **WHITE** Code: 9845 • **BLACK** Code: 8226



- UV resistant, absorbs acoustic and mechanical vibrations
- Highly flexible with up to 400% elongation
- Sticks and seals all common building materials, even in the wet
- Contains zero solvents and is non-bubbling
- +/-25% cyclic expansion and low VOC
- Interior and exterior use



bostik.com



ROOF & GUTTER SILICONE



TRANSLUCENT 300g



- Bostik Quality
- Ideal for sealing sheet metal, roofing & guttering
- Potable water approved AS4020-1999
- Neutral Cure
- Non-Corrosive

**BOX
20**

Code: 9926

GREY 300g



- Bostik Quality
- Ideal for sealing sheet metal, roofing & guttering
- Potable water approved AS4020-1999
- Neutral Cure
- Non-Corrosive

**BOX
20**

Code: 9953

BLACK 300g



- Bostik Quality
- Ideal for sealing sheet metal, roofing & guttering
- Potable water approved AS4020-1999
- Neutral Cure
- Non-Corrosive

**BOX
20**

Code: 9812



MONACO™

Universal Cistern with Link and Seat

Code: 2090

**Upgrade to the Brand
Trusted by Professionals and
Toilet Manufacturers Worldwide**

- Extra Easy Install Features Built-in
- 4.5/3L Dual Flush Technology
- Simple Flush Volume Conversion to 6/3L or 9/4.5L
- Plastic Cistern with Bottom Inlet
- UV Resistant – Certified
- Saves Water



YEAR WARRANTY

EQUIPPED WITH FLUIDMASTER TECHNOLOGY



**Inlet Valve
400UK063**



**Outlet Valve
560AU02**



FLUIDMASTER PRO CISTERN

Most Powerful Flush System
Adjustable up to 9/4.5L PRO Cistern
with Link and Seat



4.5/3L Dual Flush Technology
Simple Flush Volume
Conversion
to 6/3L or 9/4.5L

UV Resistant – Certified
Plastic Cistern with Bottom Inlet
Saves Water

INSTALL WITH CONFIDENCE

\$109¹⁰
INC. GST

Code: 2089



SPECIFICALLY DESIGNED FOR CUTTING PVC



**30% MORE
EFFICIENT THAN
STANDARD BLADES**

**CUTS STRAIGHT
EVERYTIME**

**BATTERIES
LAST LONGER**

**CUT IS FREE
OF BURRS**



SAMURAI RECIPROCATING SAW BLADE PVC

• 210mm • 16TPI • Made in Japan

**AVAILABLE IN A
BOX of 10**

\$19.51 EACH
INC. GST
Code: 9632

COPPER ROUNDING TOOL

NEW

3/4" \$55.64
INC. GST

Code: 9898

Suitable for 3/4" copper tube

1/2" \$52.88
INC. GST

Code: 9988

Suitable for 1/2" copper tube

- Saves time
- Nuts slide on easily
- Great frustration saver
- Lightweight and compact

**ROUNDS
OUT
COPPER IN
SECONDS!**

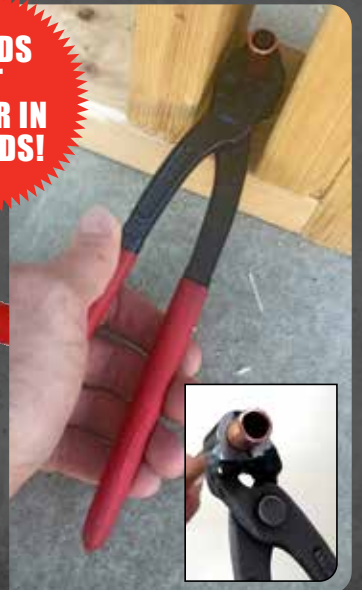

plumtool™

Innovative tools for **PLUMBERS**

SPECIAL

PRESS FITTINGS

PRESS WATER COUPLING

\$2.20
INC. GST

15mm Code: 8601



\$3.52
INC. GST

20mm Code: 8602

PRESS WATER TEE

\$3.96
INC. GST

15mm Code: 8617



\$7.37
INC. GST

20mm Code: 8618

**PRESS WATER SLIP
REPAIR COUPLING**

\$2.75
INC. GST

15mm Code: 8604



\$4.40
INC. GST

20mm Code: 8605

**BLOCKHEAD
PRESS WATER
ELBOW LUGGED
(90MM)**

NEW



\$11.00
INC. GST

15mm x 15MI Code: 8699

**PRESS WATER
ELBOW F/F**

\$2.53
INC. GST

15mm Code: 8607



\$4.29
INC. GST

20mm Code: 8608

**PRESS WATER
MI ADAPTER**

\$3.85
INC. GST

15mm Code: 8633



\$7.26
INC. GST

20mm Code: 8634

Valid until December 31st 2021

COPPER & BRASS LARGE PRESS FITTINGS

32-50mm



PRESS WATER FITTINGS

CODE	SIZE
Press Water Coupling	
7901	Press Water Coupling 32mm
7902	Press Water Coupling 40mm
7903	Press Water Coupling 50mm
Press Water Slip Repair Coupling	
7904	Press Water Slip Repair Coupling 32mm
7905	Press Water Slip Repair Coupling 40mm
7906	Press Water Slip Repair Coupling 50mm
Press Water Reducing Coupling F/F	
7907	Press Water Reducing Coupling 32 x 20mm F/F
7908	Press Water Reducing Coupling 32 x 25mm F/F
7909	Press Water Reducing Coupling 40 x 20mm F/F
7910	Press Water Reducing Coupling 40 x 25mm F/F
7911	Press Water Reducing Coupling 40 x 32mm F/F
7912	Press Water Reducing Coupling 50 x 20mm F/F
7913	Press Water Reducing Coupling 50 x 25mm F/F
7914	Press Water Reducing Coupling 50 x 32mm F/F
7915	Press Water Reducing Coupling 50 x 40mm F/F
Press Water Reducer M/F	
7916	Press Water Reducer 32 x 20mm M/F
7917	Press Water Reducer 32 x 25mm M/F
7918	Press Water Reducer 40 x 20mm M/F
7919	Press Water Reducer 40 x 25mm M/F
7920	Press Water Reducer 40 x 32mm M/F
7921	Press Water Reducer 50 x 25mm M/F
7922	Press Water Reducer 50 x 32mm M/F
7923	Press Water Reducer 50 x 40mm M/F
Press Water Elbow F/F 90°	
7924	Press Water Elbow 32mm x 90 F/F
7925	Press Water Elbow 40mm x 90 F/F
7926	Press Water Elbow 50mm x 90 F/F

CODE	SIZE
Press Water Elbow M/F 90°	
7927	Press Water Elbow 32mm x 90 M/F
7928	Press Water Elbow 40mm x 90 M/F
7929	Press Water Elbow 50mm x 90 M/F
Press Water Elbow F/F 45°	
7930	Press Water Elbow 32mm x 45 F/F
7931	Press Water Elbow 40mm x 45 F/F
7932	Press Water Elbow 50mm x 45 F/F
Press Water Tee	
7933	Press Water Tee 32mm
7934	Press Water Tee 40mm
7935	Press Water Tee 50mm
Press Water Tee Reducing	
7936	Press Water Tee 32 x 32 x 20
7937	Press Water Tee 32 x 32 x 25
7938	Press Water Tee 40 x 40 x 25
7939	Press Water Tee 40 x 40 x 32
7940	Press Water Tee 50 x 50 x 25
7941	Press Water Tee 50 x 50 x 32
7942	Press Water Tee 50 x 50 x 40
Press Water End Cap	
7943	Press Water End Cap 32mm
7944	Press Water End Cap 40mm
7945	Press Water End Cap 50mm
Press Water Adaptor MI	
7946	Press Water Adaptor 32mm x 32MI
7947	Press Water Adaptor 40mm x 40MI
7948	Press Water Adaptor 50mm x 50MI
Press Water Adaptor FI	
7949	Press Water Adaptor 32mm x 32FI
7950	Press Water Adaptor 40mm x 40FI
7951	Press Water Adaptor 50mm x 50FI

PRESS GAS FITTINGS

CODE	SIZE
Press Gas Coupling	
7952	Press Gas Coupling 32mm
7953	Press Gas Coupling 40mm
7954	Press Gas Coupling 50mm
Press Gas Slip Repair Coupling	
7955	Press Gas Slip Repair Coupling 32mm
7956	Press Gas Slip Repair Coupling 40mm
7957	Press Gas Slip Repair Coupling 50mm
Press Gas Reducing Coupling F/F	
7958	Press Gas Reducing Coupling 32 x 20mm F/F
7959	Press Gas Reducing Coupling 32 x 25mm F/F
7960	Press Gas Reducing Coupling 40 x 25mm F/F
7961	Press Gas Reducing Coupling 40 x 32mm F/F
7962	Press Gas Reducing Coupling 50 x 25mm F/F
7963	Press Gas Reducing Coupling 50 x 32mm F/F
7964	Press Gas Reducing Coupling 50 x 40mm F/F
Press Gas Reducer M/F	
7965	Press Gas Reducer 32 x 20mm M/F
7966	Press Gas Reducer 32 x 25mm M/F
7967	Press Gas Reducer 40 x 25mm M/F
7968	Press Gas Reducer 40 x 32mm M/F
7969	Press Gas Reducer 50 x 25mm M/F
7970	Press Gas Reducer 50 x 32mm M/F
7971	Press Gas Reducer 50 x 40mm M/F
Press Gas Elbow F/F 90°	
7972	Press Gas Elbow 32mm x 90 F/F
7973	Press Gas Elbow 40mm x 90 F/F
7974	Press Gas Elbow 50mm x 90 F/F
7975	Press Gas Elbow 32mm x 45 F/F
7976	Press Gas Elbow 40mm x 45 F/F
7977	Press Gas Elbow 50mm x 45 F/F
Press Gas Tee	
7978	Press Gas Tee 32mm
7979	Press Gas Tee 40mm
7980	Press Gas Tee 50mm
Press Gas Tee Reducing	
7981	Press Gas Tee 32 x 32 x 20
7982	Press Gas Tee 32 x 32 x 25
7983	Press Gas Tee 40 x 40 x 20
7984	Press Gas Tee 40 x 40 x 25
7985	Press Gas Tee 40 x 40 x 32
7986	Press Gas Tee 50 x 50 x 25
7987	Press Gas Tee 50 x 50 x 32
7988	Press Gas Tee 50 x 50 x 40
Press Gas End Cap	
7989	Press Gas End Cap 32mm
7990	Press Gas End Cap 40mm
7991	Press Gas End Cap 50mm
Press Gas Adaptor MI	
7992	Press Gas Adaptor 32mm x 32MI
7993	Press Gas Adaptor 40mm x 40MI
7994	Press Gas Adaptor 50mm x 50MI
Press Gas Adaptor FI	
7995	Press Gas Adaptor 32mm x 32FI
7996	Press Gas Adaptor 40mm x 40FI
7997	Press Gas Adaptor 50mm x 50FI



PRESS GAS FITTINGS



PRESS GAS COUPLING

CODE	SIZE	PRICE
8639	15mm	\$6.26
8640	20mm	\$8.04
8641	25mm	\$13.75



PRESS GAS SLIP REPAIR COUPLING

CODE	SIZE	PRICE
8642	15mm	\$6.00
8643	20mm	\$7.54
8644	25mm	\$11.69



PRESS GAS ELBOW F/F 90°

CODE	SIZE	PRICE
8645	15mm x 90	\$7.44
8646	20mm x 90	\$9.72
8647	25mm x 90	\$17.86



PRESS GAS ELBOW F/F 45°

CODE	SIZE	PRICE
8648	20mm x 45	\$11.60
8649	25mm x 45	\$15.46



PRESS GAS REDUCING COUPLING F/F

CODE	SIZE	PRICE
8650	20mm x 15mm	\$11.11
8651	25mm x 20mm	\$13.70



PRESS GAS REDUCER M/F

CODE	SIZE	PRICE
8652	20mm x 15mm	\$9.71
8653	25mm x 20mm	\$13.12



PRESS GAS TEE

CODE	SIZE	PRICE
8654	15mm	\$8.59
8655	20mm	\$14.81
8656	25mm	\$23.15



PRESS GAS TEE REDUCING

CODE	SIZE	PRICE
8657	20 x 20 x 15	\$15.29
8658	25 x 25 x 15	\$23.52
8659	25 x 25 x 20	\$26.00



PRESS GAS END CAP

CODE	SIZE	PRICE
8660	15mm	\$8.10
8661	20mm	\$9.13
8662	25mm	\$16.08



PRESS GAS ELBOW LUGGED

CODE	SIZE	PRICE
8663	15mm x 15FI	\$18.40
8664	20mm x 20FI	\$20.12



BLOCKHEAD PRESS GAS ELBOW LUGGED (90MM)

CODE	SIZE	PRICE
8698	15mm x 15MI	\$18.40



PRESS GAS ADAPTOR MI

CODE	SIZE	PRICE
8666	15mm x 15MI	\$5.51
8667	20mm x 20MI	\$13.59
8668	25mm x 25MI	\$21.39



PRESS GAS ADAPTOR FI

CODE	SIZE	PRICE
8669	15mm x 15FI	\$7.44
8670	20mm x 20FI	\$11.32
8671	25mm x 25FI	\$15.43

25 YEAR WARRANTY*

Brasshards is proud to offer a 25 year warranty against defects and manufacturing faults in CuPress fittings (when installed in accordance with national, state and local plumbing codes by a licensed plumber). Issues arising from incorrect installation, misuse or environmental elements are not covered by this warranty. Please contact Brasshards for a copy of our full warranty document.

PRESS WATER FITTINGS



PRESS WATER COUPLING

CODE	SIZE	PRICE
8601	15mm	\$2.20 <small>SPECIAL</small>
8602	20mm	\$3.52 <small>SPECIAL</small>
8603	25mm	\$8.70



PRESS WATER SLIP REPAIR COUPLING

CODE	SIZE	PRICE
8604	15mm	\$2.75 <small>SPECIAL</small>
8605	20mm	\$4.40 <small>SPECIAL</small>
8606	25mm	\$10.52



PRESS WATER ELBOW F/F 90°

CODE	SIZE	PRICE
8607	15mm x 90	\$2.53 <small>SPECIAL</small>
8608	20mm x 90	\$4.29 <small>SPECIAL</small>
8609	25mm x 90	\$13.24



PRESS WATER ELBOW F/F 45°

CODE	SIZE	PRICE
8610	15mm x 45	\$5.86
8611	20mm x 45	\$8.08
8612	25mm x 45	\$14.87



PRESS WATER ELBOW M/F 90°

CODE	SIZE	PRICE
8681	15mm	\$5.41
8682	20mm	\$7.11



PRESS WATER REDUCING COUPLING F/F

CODE	SIZE	PRICE
8613	20mm x 15mm	\$9.38
8614	25mm x 20mm	\$15.99



PRESS WATER REDUCER M/F

CODE	SIZE	PRICE
8615	20mm x 15mm	\$8.41
8616	25mm x 20mm	\$11.94



PRESS WATER END CAP

CODE	SIZE	PRICE
8623	15mm	\$7.43
8624	20mm	\$9.00
8625	25mm	\$17.63



PRESS WATER TEE

CODE	SIZE	PRICE
8617	15mm	\$3.96 <small>SPECIAL</small>
8618	20mm	\$7.37 <small>SPECIAL</small>
8619	25mm	\$20.21



PRESS WATER TEE REDUCING

CODE	SIZE	PRICE
8620	20 x 20 x 15	\$13.51
8621	25 x 25 x 15	\$19.12
8622	25 x 25 x 20	\$22.96
8683	20 x 15 x 15	\$17.84
8684	20 x 15 x 20	\$18.77



PRESS WATER ELBOW LUGGED

CODE	SIZE	PRICE
8626	15mm x 15FI	\$13.36
8627	20mm x 20FI	\$19.05



BLOCKHEAD PRESS WATER ELBOW LUGGED (90MM)

CODE	SIZE	PRICE
8699	15mm x 15MI	\$11.00 <small>SPECIAL</small>



PRESS WATER ELBOW FI

CODE	SIZE	PRICE
8629	15mm x 15FI	\$14.77
8630	20mm x 20FI	\$17.88



PRESS WATER ELBOW MI

CODE	SIZE	PRICE
8631	15mm x 15MI	\$14.23
8632	20mm x 20MI	\$17.89



PRESS WATER ELBOW UNION

CODE	SIZE	PRICE
8687	15mm x 1/2"	\$9.03
8688	20mm x 3/4"	\$13.64



PRESS WATER ADAPTOR MI

CODE	SIZE	PRICE
8633	15mm x 15MI	\$3.85 <small>SPECIAL</small>
8680	15mm x 20MI	\$10.60
8634	20mm x 20MI	\$7.26 <small>SPECIAL</small>
8635	25mm x 25MI	\$20.52



PRESS WATER ADAPTOR FI

CODE	SIZE	PRICE
8636	15mm x 15FI	\$6.59
8637	20mm x 20FI	\$8.41
8638	25mm x 25FI	\$14.99



PRESS UNION

CODE	SIZE	PRICE
8685	15mm Loose Nut x 15mm Press (Flat Seat)	\$11.61
8679	20mm Loose Nut x 20mm Press (Flat Seat)	\$11.75

- Flame-free
- Permanent V-Profile press join
- All fittings comply with Australian Standards AS3688



BIGGEST TIMBER SHORTAGE IN OVER 40 YEARS

SAVE A LOG BUY A
FASTANOG

**BLOCK
HEAD**

BLOCKHEAD LUGGED ELBOW

- Reduce the number of noggins required
- Can press it while in place
- Fix it from any direction
- Lead-free brass
- 25 year warranty

Same
price as a
traditional
luggie!

Blockhead Press
Water Elbow Lugged
15mm x 15MI (90mm)

Code: 8699

Blockhead Press
Gas Elbow Lugged
15mm x 15MI (90mm)

Code: 8698



Traditional Fix
Plumber's noggin



Stud Fix
Fix to side of studs



Existing Noggin
Fix to carpenter's noggin

BRASSHARDS
EST. 1967

| PLUMBING SUPPLIES SPECIALIST |

W
WaterMark

PATENTED

Under licence no. 2001

FASTANOG BLOCK

4x FASTER

- Pre-loaded with bugle screws
- Set back measurer
- Fits small spaces
- Strong and versatile

CODE: 1475

AVAILABLE IN A
BOX OF 10



FASTANOG

PRELOADED WITH HEX SD SCREW

Extends 330mm – 600mm



Drill



Hex SD Screw



CODE: 1471



PRELOADED WITH BUGLE SCREW

Extends 330mm – 600mm



Drill



Bugle Screw

CODE: 1464



MINI PRELOADED WITH BUGLE SCREW

Extends 190mm – 330mm



Drill



Bugle Screw

CODE: 1474



SAY GOODBYE TO TIMBER NOGGINS

PATENTED

STEEL STUDWORK?

plumbers choice

HAS THE ANSWERS!

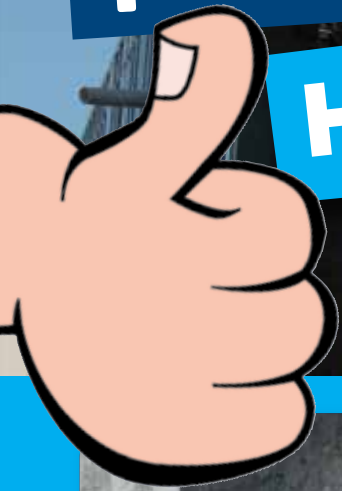

34MM
AND
58MM



STEEL STUD DRILL

- Also great in roofing work for overflows, etc
- 34mm to suit yellow grommets
- 58mm for drainage vents

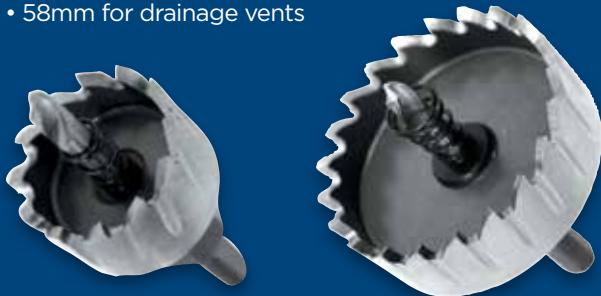

34mm

58mm

\$70⁵⁵
INC. GST
Code: 2000

\$152⁰⁹
INC. GST
Code: 2001



STUD CLIPS - WITH SD SCREW

- Works in any size hole

— — — —
| BAG |
| 100 |
— — — —

16MM
AND
20MM



16mm

20mm

\$29⁰⁸
INC. GST
Code: 5571

\$30⁸⁹
INC. GST
Code: 5572



\$599³⁷
INC. GST
Code: 1914

STUD PUNCH

- For the plumber in a hurry!
- Designed for cutting holes in steel stud work
- Cuts holes super fast



BAG 100

\$427⁴
INC. GST
Code: 9241



MULTI-FIT GROMMET

Works in varying thicknesses of studwork (thickness 0.42mm to 2mm)
Complies to Australian Standards AS3500.1 12 Clause 5.5 2.2 Part C



ONE CLIP FITS 16MM - 20MM PEX PIPE



BAG 100



\$331⁹
INC. GST
Code: 5558

DUALPEX CLIP SD SCREW

BAG 100



\$355⁹
INC. GST
Code: 5575

DUALPEX CLIP SD SCREW WITH TAB

BAG 100



16mm
Code: 4526 **\$33.17**
20mm
Code: 4527 **\$36.71**

PEX SADDLES SD SCREW WITH TAB

PRELOADED

WITH HEX SD SCREWS
Code: 1471



330mm - 600mm

UNLOADED

Code: 1450



330mm - 600mm

MINI PRELOADED

WITH BUGLE SCREWS
Code: 1474



190mm - 330mm

FASTANOG

- Faster than timber noggins
- Compulsory in termite areas
- Set back measurer



preloaded
set back measurer

SLIDE TO ADJUST LENGTH



NEW!

WOMBAT



- Australian Designed
- Brass Shroud prevents spreading and splitting
- Tough NP3 compound which is heat resistant and hardwearing
- Passes 100,000 cycle test
- Complies with AS3718

10 Pack
Code: 8810

100 Pack
Code: 8811

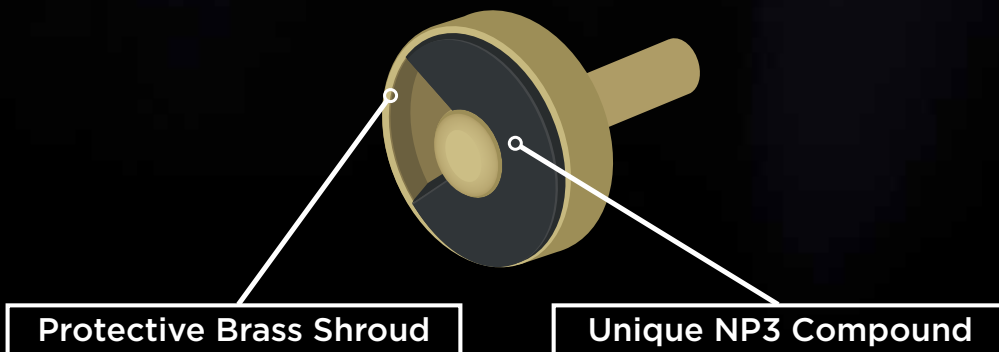

Drainla®

For use on pipework passing through concrete footings

DOES YOUR JOB COMPLY?



DONT GET CAUGHT OUT!

Drainlag complies with AS1345-1995 (Table 1) indicating that pipes containing sewerage and organic waste should be marked black.

Drainlag Black

- 100mm x 10 Metre Roll
- Closed Cell
- Non Absorbant
- Simple to apply to pipe and or fittings
- Complies with the following standards:

AS3500 3.8.2 (b)

"Shall be installed with not less than 25mm annular space"

AS 1345-1995 (Table 1)

Colour Identification for Sewerage & Organic waste: Black

AS2870 5.5.4 (a)

"Closed cell polyethylene lagging shall be used around all drainage pipes through external footings"

Code: 8720

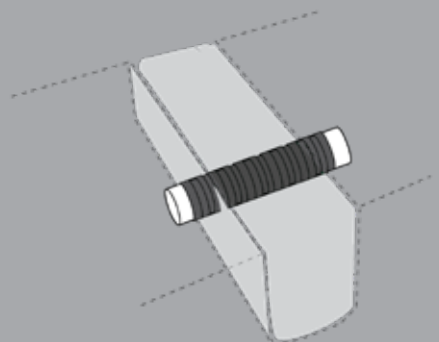
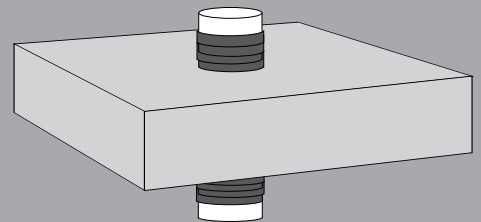

ECO
FRIENDLY
PACKAGING

CHS CHRIS HUNTER
SALES

MADE
FROM
RECYCLED
MATERIALS

**TRAP
DRILL**



\$50 **SAVE \$18.93**

INC. GST
Code: 2601

**GULLY
GRABBER**



\$200 **SAVE \$78.26**

INC. GST
Code: 2610

**DELUXE
TAP S**

\$12



plumtool™

CHRISTMAS



**7 PIECE
TURN UP TOOL**

\$200

INC. GST
Code: 1754

**SAVE
\$80.60**



**plumtool
Tube Spanner Kit**
Ideal for removal and installation of gutters.
Made in Australia

\$135

INC. GST
Code: 2513

**SAVE
\$56.43**



**DRILL MIXER
SOCKET SET**

\$66.50

INC. GST
Code: 9885

**SAVE
\$48.27**



**WIDE
OPENING
SHIFTER
SET**

\$135

INC. GST
Code: 5012

**SAVE
\$52.42**

SPECIALS

Valid until December 31st 2021

**ORDER
NOW**

SPECIAL

PRESSURE REDUCTION VALVES

\$44

INC. GST

PRV RIGHT ANGLE AVG

- Preset 500kPa
- 20mm (3/4 inch) BSP female by copper olive compression
- Stainless Steel Seat

Code: 3602



\$44

INC. GST

PRV RIGHT 20MM RA AVG

- Preset 500kPa
- 20mm (3/4 inch) BSP female by flared compression
- Stainless Steel Seat

Code: 3609



PRV 20MM 250-605 KPA

- 250-605 kPa
- Preset 500kPa
- 20mm (3/4 inch) BSP F&F
- Stainless Steel Seat

Code: 3603

\$44

INC. GST

\$49⁵⁰

INC. GST

PRV BALL VALVE

- Combination 20mm PRV & isolation ball valve
- Quick and easy to install
- Stainless Steel Seat

Code: 3600



\$33

INC. GST

TRI-SET VALVES

- One valve with three pressure settings 350kPa, 500kPa & 600kPa
- Compression 15mm Code: 3610
Female 15mm Code: 3611

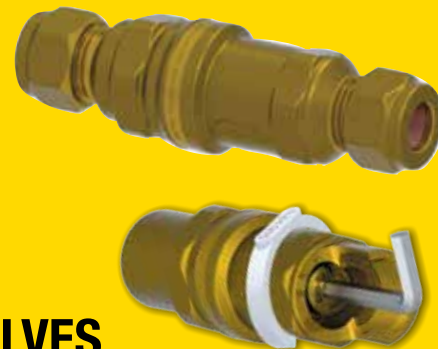

Valid until December 31st 2021

W
WaterMark

UV STABILISED BLACK NYLON TAP-INS WILL NOT FAIL!



- Black Tap-Ins will not fail when exposed to the sun
- Decero coated nails will not rust (exceeds 1000 hour salt spray test)



BOX 500



NYLON TAP-INS - UV BLACK

- For outdoor use
- Black Nylon UV stabilised will not perish

CODE	LENGTH	QTY	PRICE
9524	5mm x 25mm	500	\$81.76
1187	5mm x 40mm	500	\$114.41

BOX 100

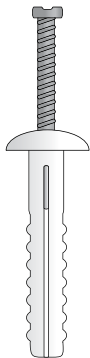

NYLON TAP-INS - MUSHROOM HEAD

- 100% nylon, not plastic

CODE	LENGTH	QTY	PRICE
9345	5mm x 25mm	100	\$15.09
9925	6.5mm x 50mm	100	\$20.90

BOX 100

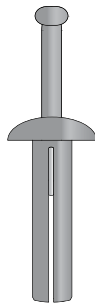

METAL TAP-INS - MUSHROOM HEAD

- Strong cast alloy

CODE	LENGTH	QTY	PRICE
9387	5mm x 25mm	100	\$34.46
1967	6.5mm x 25mm	100	\$43.81
1968	6.5mm x 32mm	100	\$46.72
1705	6.5mm x 40mm	100	\$49.51

NYLON TAP-INS - ROUND HEAD

- 100% nylon, not plastic

CODE	LENGTH	QTY	PRICE
9978	5mm x 25mm	100	\$14.78
9907	5mm x 25mm	500	\$65.24
9179	5mm x 40mm	100	\$21.14
9973	5mm x 40mm	500	\$90.51
9567	6.5mm x 25mm	100	\$15.35
2262	6.5mm x 40mm	100	\$22.07

*All prices include GST

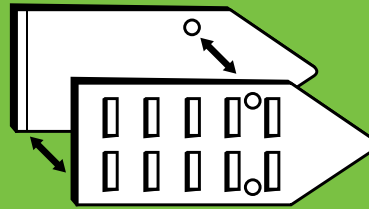

BAG QTY 50
\$58.42 INC. GST
 Code: 1222

STYROWEDGE

A wedge type fastening for polystyrene walls

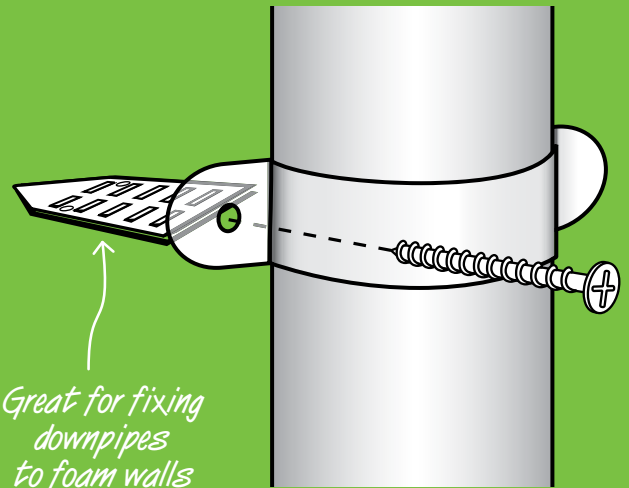

Great for fixing downpipes to foam walls

NB. Ensure all penetrations are sealed.



Step 1 Using a sharp blade, cut a 30mm slot, 50mm deep into the wall.



Step 2 Take 2 Styrowedge halves and join the smooth sides together.



Step 3 Insert the Styrowedge into the slot in the wall.



Step 4 Ensure the Styrowedge is flush with the finish of the wall.



Step 5 Place the downpipe and clip in position on the wall. Insert an 8-12 gauge screw into the Styrowedge and tighten into place.



Step 6 Complete for remaining fastenings.

- For a professional finish inside the cupboard.
- Flexy Flange cupboard plate fits tight to pipe which makes it ant-proof.

1 Flexy Flange Fits 4 Sizes!



80mm

Suits 9-22mm pipe

Small

Pack Qty 10

\$22.64 INC. GST

Code: 8250

PATENTED



90mm

Suits 22-44mm pipe

Medium

Pack Qty 5

\$15.04 INC. GST

Code: 8252

PATENTED

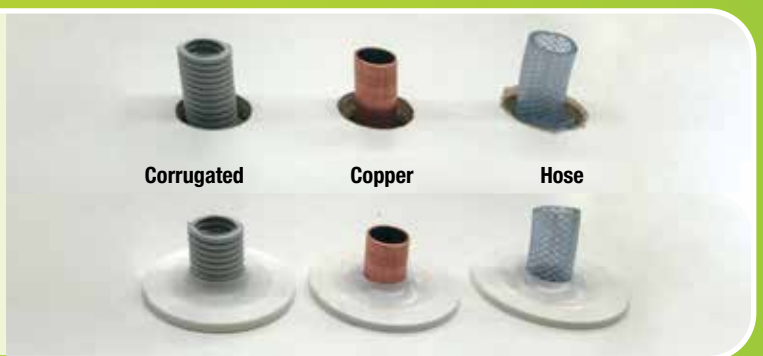

105mm

Suits 40-60mm pipe

Large

Pack Qty 5

\$16.74 INC. GST

Code: 9968

PATENTED



115mm

170mm

Suits 40-60mm pipe

Rectangle

Pack Qty 5

\$22.26 INC. GST

Code: 2202

PATENTED



EXTENDO

GAS CONNECTOR

F + F NOW AVAILABLE



BROMIC
PLUMBING & GAS

Extendable
from **650mm**
to **1200mm**

- ✓ Saves Space, **ONE Connector does it all!**
- ✓ 12mm internal bore for better gas flow
- ✓ Flame resistant stainless steel
- ✓ AGA Approved 8633G
- ✓ 1/2" M+F
- ✓ 1/2" F+F

HANDY TIP:
Attach a brass tee to either end
to create a handle

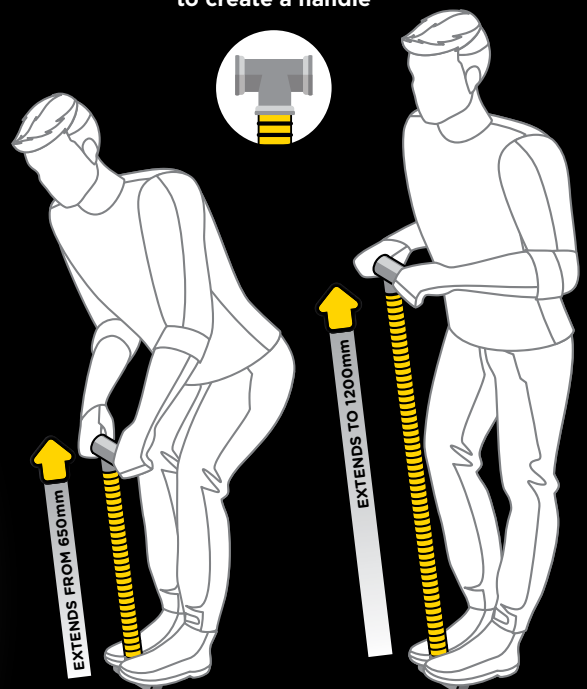

BOX
10

\$246.78
INC. GST

M+F Code: 6176
F+F Code: 6178



MULTI PURPOSE COVER PLATE

Suitable for Washing Machines & Dishwashers

- Leave a neat finish in the cupboard
 - Covers a hole in the cupboard up to 120mm x 115mm
 - Keeps pests out
 - Fits hot & cold hoses, power cord, Optional outlet hose cap
- Code: 1796**



STAINLESS STEEL

 <p>Flat 1/2" BSP Pack Qty 50 Code 9154</p>	 <p>10mm Rise 1/2" BSP Pack Qty 50 Code 9153</p>	 <p>16mm Rise 1/2" BSP Pack Qty 10 Code 1652</p>	 <p>22mm Rise 1/2" BSP Pack Qty 10 Code 1653</p>
 <p>34mm Rise 1/2" BSP Pack Qty 1 Code 1649</p>	 <p>10mm Rise 3/4" BSP Pack Qty 10 Code 1276</p>	 <p>Flat 1/2" Copper Pack Qty 50 Code 9539</p>	 <p>10mm Rise 1/2" Copper Pack Qty 50 Code 1238</p>



DISHWASHER COVER PLATES

"For the professional plumber"

- Leave a neat finish in the cupboard
- Keeps pests out
- Fits over the solenoid valve

Code: 1792



STUBBIE

TEST CAP

Sometimes shorter is better!

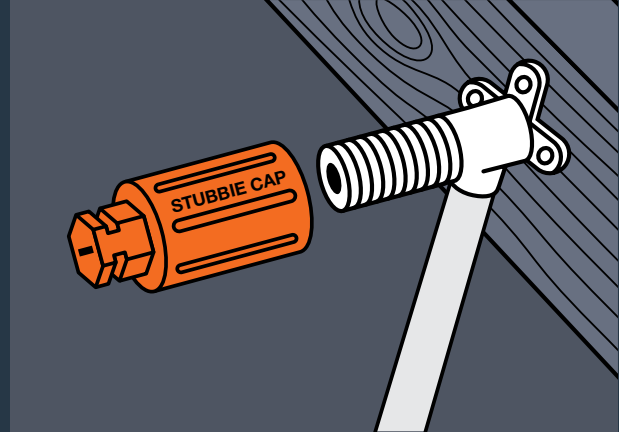

- Easier to install cabinets
- Can be removed with screwdriver or shifter
- Safer high visibility
- Available in a bag of 100

\$1.27 each
INC. GST
Code: 4803



BRASS STUBBIE TEST CAP

- Shorter, makes it easier to install cabinets.
- Never leaks or fails
- Use over & over again

\$7.52 each
INC. GST
Code: 4804



TEST PLUG DUO RED

- Duo plug and cap combination
- For test hot and cold water installations
- 5/8 BSP Male Plug
- 1/2 BSP Female Cap

\$2.77 each
INC. GST
Code: 5052



TEST CAP DRAINABLE

- Small removable plug for easy drainage of water line
- Eliminates spilling inside wall cavity

\$2.61 each
INC. GST
Code: 5053

YOU SPOKE, WE LISTENED!

To continue to make things easier for you to support Trade Only, we've made a few additions to www.plumberschoice.com.au



ORDER TEMPLATES



FAVOURITES



QUOTES

Save Order Templates

You can now save custom Order Templates.

With just one click, add all the items from your Order Template to your shopping cart. Perfect for fit off packs, hottie kits or end of month stock top ups.

Favourite Items

Access to your favourite and most used items on the one page.

No more scrolling through to add the same items you buy every order. Now add them all from the convenience of one page.

Request a Quote

Want some gear quoted?

Haven't had some items priced up by your Sales Rep yet? Well, from the cart page you can now order or request a quote on the gear in your shopping cart.

Don't have an online account yet?

Head to www.plumberschoice.com.au/register/ and sign up today. Order any time from the convenience of your phone or laptop.



TIP OF
THE
MONTH



We'll tip
YOU
when you tip
US!



Every featured story receives a
\$200 Store Credit

Use an off cut of PVC to suspend a toilet suite off your shoulders. Allows your legs to take the weight and makes it easy to navigate tight spaces.



Thanks to John - LK Plumbing
\$200 store credit is coming your way

To get involved send us an email info@plumberschoice.com.au

NEW!

BAL RATED DRAINAGE VENT & FLASHING KIT

Kit includes:

- Steel vent and cowl
- BAL rated flashing to suit steel roof
- Steel to PVC insulated adaptor

PATENTED

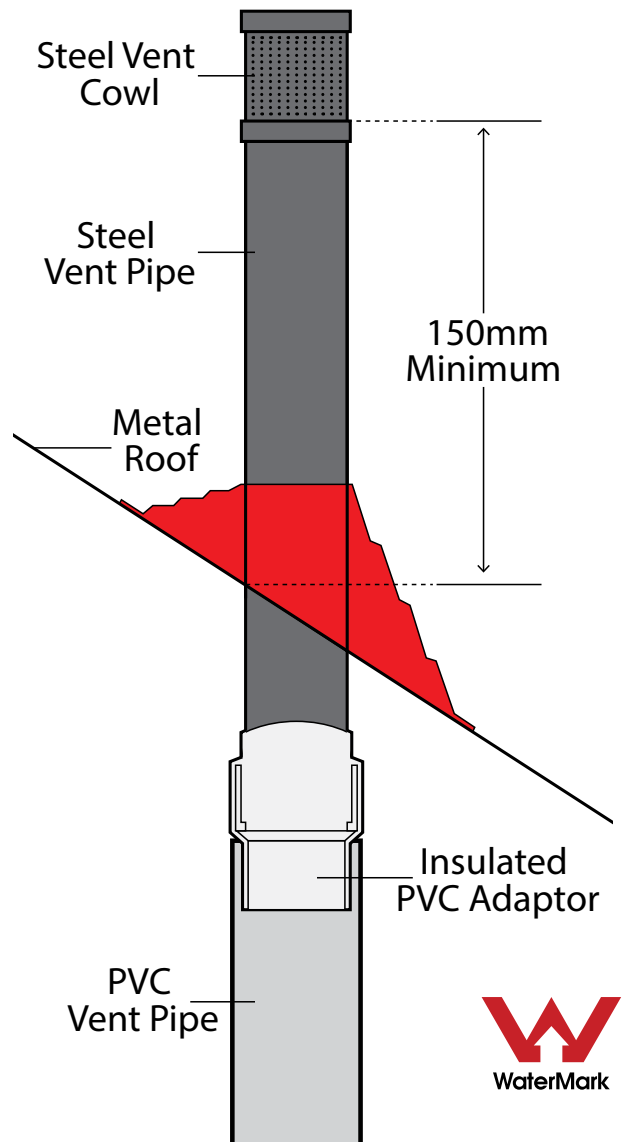

BAL12.5
Black Flashing Kit

Code: **8876**



BAL29
Red Silicone Kit

Code: **8877**



MONUMENT PVC CUTTERS



QUICK & CLEAN CUT!



**PIPE CUTTER
AUTOCUT MONUMENT
50MM PVC**

\$53⁰²

INC. GST
Code: 2645



**PIPE CUTTER
AUTOCUT MONUMENT
40MM PVC**

\$49⁷²

INC. GST
Code: 2644

- Quality UK designed and made
- Quick and clean cut
- Light weight
- Ideal for confined spaces
- Spare blades available



PIPE CUTTER SPARE BLADES
For Monument PVC Autocutters Per 5

- Spare blade suits both 40 & 50mm cutters

\$17⁰⁵

INC. GST
Code: 2646

MONUMENT TOOLS

SPECIAL

POLY COMPRESSION FITTINGS

POLY METRIC
COUPLING

\$7.70
INC. GST

25mm Code: 7145



POLY METRIC
ELBOW

\$8.80
INC. GST

25mm - 25mm Code: 7158



POLY METRIC
SLIP REPAIR
COUPLING

\$9.90
INC. GST

25mm Code: 7172



POLY METRIC
ADAPTOR MALE

\$5.50
INC. GST

25mm-3/4" Code: 7148



POLY METRIC
CONNECTOR PE-CU

\$9.90
INC. GST

25mm - 3/4" Code: 7140



POLY METRIC
ADAPTOR MALE

\$5.50
INC. GST

25mm - 1" Code: 7149



POLY METRIC
CONNECTOR PE-CU

\$10.45
INC. GST

25mm-1/2" Code: 7176



POLY METRIC
TEE

\$10.45
INC. GST

25mm Code: 7156



Valid until December 31st 2021

NEW

SADDLE FOR POLY PIPE

WITH MASONRY NAIL

- Suits 25mm PE Pipe
- UV Stabilised

\$49⁷²
INC. GST
Code: 9050

BAG
25



**KEEPS
PIPEWORK
OFF THE
SUBSTRATE**

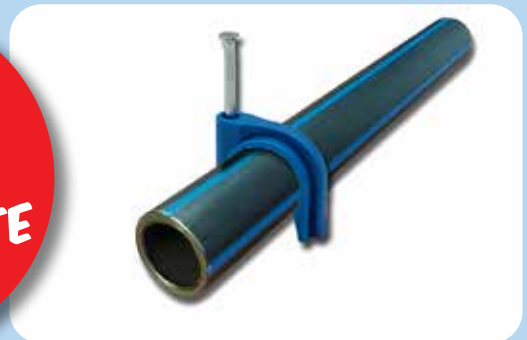

**DON'T TAKE
THE RISK!
REACH
FOR THE
GULLY
GRABBER**

GULLY GRABBER

**EXTENDS
UP TO
2M**

The **Gully Grabber** is designed to remove hazards and blockages safely

- Extends up to 2 metres
- Stores in a handy 600mm tube
- Genuine Plumtool
- Patented



**CHRISTMAS
SPECIAL
SAVE
\$78.26**

\$200⁰⁰
INC. GST

CODE: 2610



LEVEL GRADIENT ADJUSTABLE

**ADJUSTABLE
600mm**

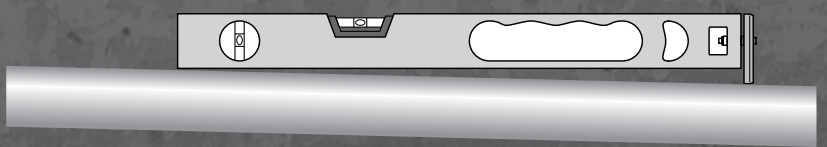

\$205⁶¹
INC. GST

CODE: 2493

- Great drainers' tool
- Set dial to gradient required
- As used by plumbing inspectors
- Can also be used as a standard level

plumtool™

Innovative tools for **PLUMBERS**

Jacko's Review

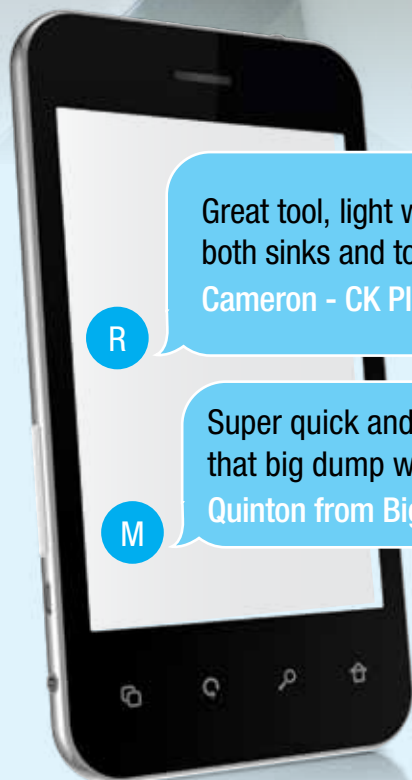

Great tool, light weight and works well on both sinks and toilets

Cameron - CK Plumbing & Gas

R

Super quick and easy to use, clear away that big dump with one pump

Quinton from Big Cat Plumbing

M

plumtool™

Pump Action Drain Cleaner



SPECIAL

\$154.00 INC. GST

Code: 3999

SAVE \$24.52

- Built for professionals
- Best of breed pump action drain plunger
- Comes with two rubber adaptors, one for sinks one for toilets

Quickie Kit



Connections to unit allow for height adjustment

Universal swivel fittings for sideways adjustment

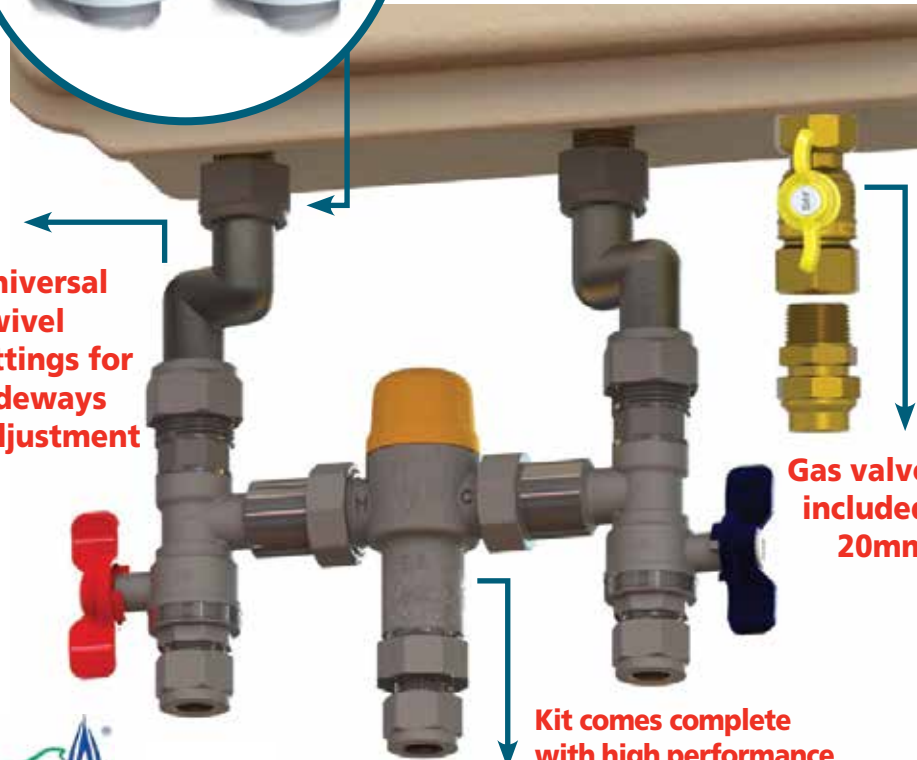

Gas valve included 20mm

Kit comes complete with high performance tempering valve



24 Month warranty



Insulation & cable ties provided to comply with AS3500

Fit-off a hot water service in minutes!
Suits all instantaneous hot water services.

15mm outlet & tempering valve Code: 8300 | 20mm outlet & tempering valve Code: 8301

Andrew from AMT Plumbing in Bayswater said:

I recently tried the Quickie Kit on an install. I reckon it saved me at least 30-45 minutes. The insulation and cable ties included in the kit made for a nice neat finish. Everything I needed was there.

Loose Nut Ball Valve Kit with Union

- Gas 20mm loose nut x 20mm female
- Water 20mm loose nut x 20mm female
- Outlet fitting 20Fi x 20C

Code: 8306

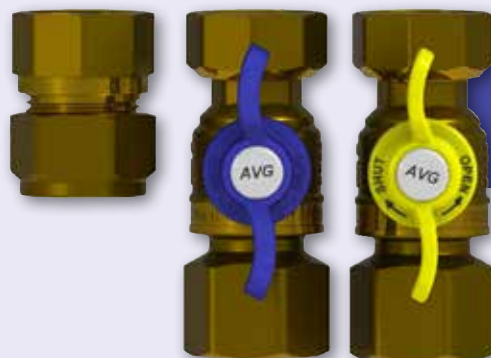

Instantaneous Continuous Flow Kit



REPAIR CLAMPS

INTRODUCING

SPECIAL PRICE \$38⁵⁰

REPAIR CLAMP FOR COPPER 15mm

- Stainless Steel Band Simple to install
- Suits 1/2 inch copper
- Made from 316 stainless steel
- Full circle nitrile rubber gasket
- Pressure rating of 1600kPa
- Approved for use in potable water supply



Code: 5060

REPAIR CLAMP FOR COPPER 20mm

- Stainless Steel Band Simple to install
- Suits 3/4 inch copper
- Made from 316 stainless steel
- Full circle nitrile rubber gasket
- Pressure rating of 1600kPa
- Approved for use in potable water supply



Code: 5061

REPAIR CLAMP FOR COPPER 25mm

- Stainless Steel Band Simple to install
- Suits 1 inch copper
- Made from 316 stainless steel
- Full circle nitrile rubber gasket
- Pressure rating of 1600kPa
- Approved for use in potable water supply



Code: 5062

REPAIR CLAMP FOR COPPER 32mm

- Stainless Steel Band Simple to install
- Suit 1 1/4 inch copper
- Made from 316 stainless steel
- Full circle nitrile rubber gasket
- Pressure rating of 1600kPa
- Approved for use in potable water supply



Code: 5063

REPAIR CLAMP FOR GAL PIPE 20mm

- Stainless Steel Band simple to install
- Suits 3/4 inch galvanised pipe
- Made from 316 stainless steel
- Full circle nitrile rubber gasket
- Pressure rating of 1600kPa
- Approved for use in potable water supply



Code: 5064

REPAIR CLAMP FOR GAL PIPE 25mm

- Stainless Steel Band simple to install
- Suits 1 inch galvanised pipe
- Made from 316 stainless steel
- Full circle nitrile rubber gasket
- Pressure rating of 1600kPa
- Approved for use in potable water supply



Code: 5065

plumtool™

TIGHTEN BASIN & SINK MIXERS FAST

IDEAL
FOR TIGHT
SPACES

Flexible shaft for
tight spaces



Extra long
sockets (120mm)

FLEXIBLE MIXER TAP DRIVER KIT

Kit Contains:

- 3/8 Flexible Drive (200mm long)
- 3/8 Hex Adaptor (40mm long)
- 3/8 Drive Socket Set;
9mm x 120mm, 10mm x 120mm,
11mm x 120mm, 12mm x 120mm,
13mm x 120mm



\$108.08 INC. GST

Code: 9828