

plumbers choice YOUR WAY

SHOP
TRADE
ONLY

PICK YOUR SERVICE

- ✓ ONE POINT OF CONTACT
- ✓ INNOVATIVE PRODUCTS
- ✓ DELIVERY TO YOUR DOOR
- ✓ CUSTOM PRICING
- ✓ TAILORED SERVICE



ORDER YOUR WAY



CALL OR
TEXT US



WE'LL
CALL YOU



ORDER
ONLINE



SEND US
AN EMAIL



COME SEE
US INSTORE

489 Mountain Highway, Bayswater, VIC 3153
Email: info@plumberschoice.com.au • Ph: (03) 9720 8274

www.plumberschoice.com.au



Luke's Editorial

LET'S MOVE OUR INDUSTRY TO A BRIGHTER TRADE ONLY FUTURE

For plumbing businesses in Australia it has never been easier to control the destiny of their industry.

Our sales people are the best and most knowledgeable in the industry. Our sales team has combined industry experience of 210 years. You can tap into this wealth of experience and knowledge by setting your business up with one of our sales reps. You can call, email or text this rep any time. Your allocated rep can be contacted for customised pricing, product advice or helping you source those difficult to find items. You can set your rep up to call you at a specific time to assist in re-ordering. You can even come into the store and have a chat.

Our sales team is supported by the best Trade Only website in the country.

So if you feel like moving your industry to a brighter Trade Only future, now is a great time to get onboard. It's never been easier to buy Trade Only.



LUKE BOLTON
DIRECTOR, PLUMBERS CHOICE

HOW TO ORDER



Online - 24 hours

www.plumberschoice.com.au



Email - 24 hours

sales@plumberschoice.com.au



Phone - Business Hours

(03) 9720 8274

Our knowledgeable staff will take your order.



At our Trade Outlets

Monday - Friday

489 Mountain Highway, Bayswater, VIC 3153

4/200 Woodpark Road, Smithfield, NSW 2164



Personal Sales Rep

Your personal Sales Representative is able to tailor our service to suit your needs.



Shop
Trade Only
from the palm
of your hand!



Combo Digital Gas Manometer

One kit does two jobs

- Operating Range 0 kPa to 10 kPa
- Accuracy 0.5% over Operating Range
- Operating Temperature -10°C to 95°C

Kit contains:

- Digital Gauge with click on connection
- 700mm Rubber Hose with click on connection
- Testing Tee with click on connection
- Hand Bellows

Code: 1826



GAS LINE TESTING

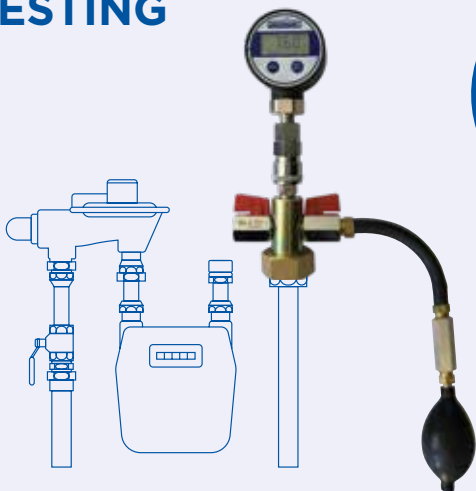

APPLIANCE TESTING

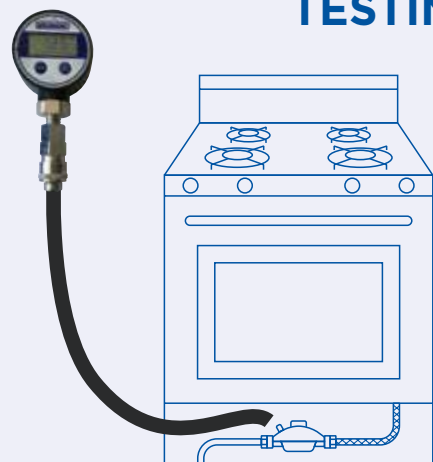

plumtool™

TIGHTEN BASIN & SINK MIXERS FAST

IDEAL
FOR TIGHT
SPACE
AREAS

Flexible shaft for
tight spaces

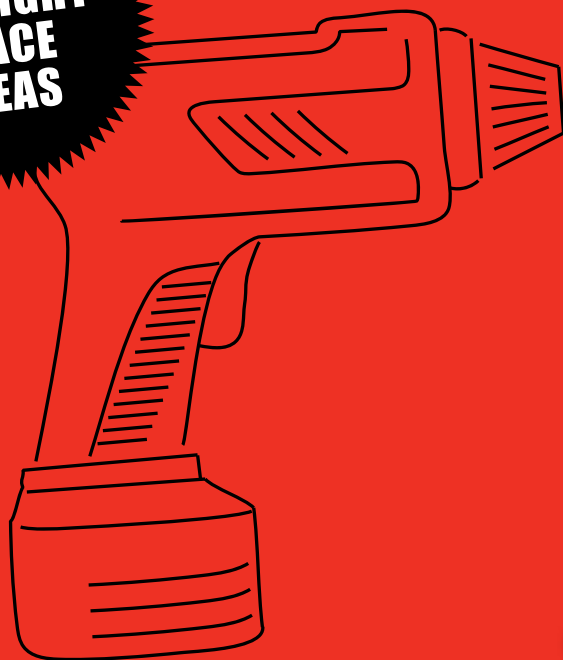

Extra long
sockets (120mm)

FLEXIBLE MIXER TAP DRIVER KIT

Kit Contains:

- 3/8 Flexible Drive (200mm long)
- 3/8 Hex Adaptor (40mm long)
- 3/8 Drive Socket Set;
9mm x 120mm, 10mm x 120mm,
11mm x 120mm, 12mm x 120mm,
13mm x 120mm



\$108.08 INC. GST

Code: 9828

BULK SPECIAL

EZY FIT CONNECTORS PEX LINED BURST PROOF



\$88.00
INC. GST

**BURST
PROOF
10 YEAR
WARRANTY**

EZY FIT WATER CONNECTOR

- Burst Proof Inner Core
- 1/2"Female x 1/2"Female Connection
- Premium 8mm Straight Water Hose

225mm QTY 25 Code: 5100
300mm QTY 25 Code: 5101
450mm QTY 25 Code: 5102



225mm
\$99.00
INC. GST

150mm
\$88.00
INC. GST

EZY FIT WATER CONNECTOR M & F EXTENSIONS

- Burst Proof Inner Core
- 1/2"Male x 1/2"Female Connection
- Ideal for extending mixer tails that are too short

150mm QTY 20 Code: 5009 \$88.00
225mm QTY 20 Code: 9155 \$99.00



10 Pairs

Valid until October 31st 2021



- For a professional finish inside the cupboard.
- Flexy Flange cupboard plate fits tight to pipe which makes it ant-proof.

1 Flexy Flange Fits 4 Sizes!



80mm

Suits 9-22mm pipe

Small

Pack Qty 10

\$22.64 INC. GST

Code: 8250

PATENTED



90mm

Suits 22-44mm pipe

Medium

Pack Qty 5

\$15.04 INC. GST

Code: 8252

PATENTED

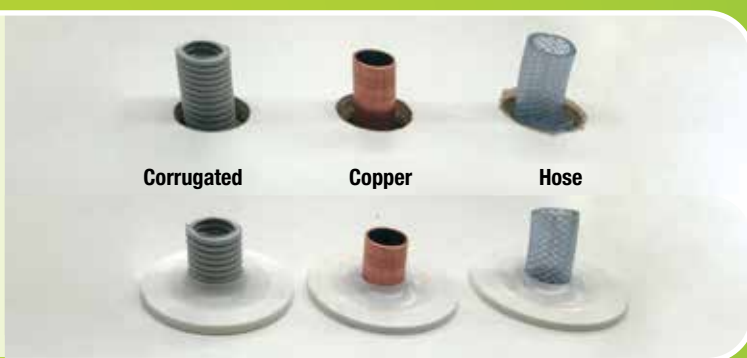

105mm

Suits 40-60mm pipe

Large

Pack Qty 5

\$16.74 INC. GST

Code: 9968

PATENTED



115mm

170mm

Suits 40-60mm pipe

Rectangle

Pack Qty 5

\$22.26 INC. GST

Code: 2202

PATENTED



BLACK COVER PLATES

Powder coated black metal. Professional architectural finish.



Flat

1/2 Inch BSP Flat

Pack Qty 1 | Code 4018 | \$13.24ea



Flat 40mm

40mm PVC Flat

Pack Qty 1 | Code 4019 | \$21.45ea



Square Flat

1/2 Inch BSP Flat

Pack Qty 1 | Code 4025 | \$20.19ea



10mm Rise

1/2 Inch BSP 10mm Rise

Pack Qty 1 | Code 4015 | \$13.97ea



Flat 50mm

50mm PVC Flat

Pack Qty 1 | Code 4020 | \$21.45ea



Square Rise

1/2 Inch BSP 10mm Rise

Pack Qty 1 | Code 4026 | \$20.19ea



Black
**TILER'S
BOO BOO**



90mm Round

Pack Qty 1 | Code 6173

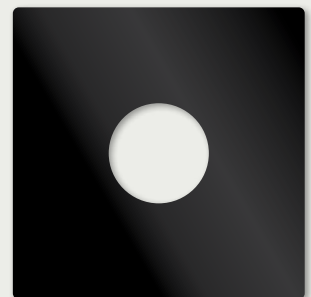

90mm Square

Pack Qty 1 | Code 6172



NEW

SHOWER MIXER FIXER



CHROME PLATED



- Replace shower mixers with ease
- Fits all mixers
- Chrome plated brass

Pack Qty 1

OVAL

Code 2987 \$90.51

RECTANGLE

Code 2983 \$92.94





COVER PLATE LABELS

- Suit any 1/2", 5/8" or 3/4" Centre Cover Plate
- Self Adhesive
- UV Stable
- Can be retrofitted

per
10



48mm

'Rainwater'
White on Green
CODE: 4901



48mm

'Rainwater'
Green on Clear
CODE: 4902



48mm

**'Rainwater
Do Not Drink'**
Green on Clear
CODE: 4903



48mm

**'Recycled Water
Do Not Drink'**
White on Lilac
CODE: 4904

STAINLESS PRINTED COVER PLATES

- UV Stable

per
1



67mm

'Rainwater'
White on Green
CODE: 4905



67mm

'Rainwater'
Green on Clear
CODE: 4907



67mm

'Recycled Water Do Not Drink'
White on Lilac
CODE: 4906

WHITE PRINTED COVER PLATES

per
10



73mm

**'Recycled
Water
Do Not Drink'**
Lilac on White
CODE: 1579



73mm

'Rainwater''
Green on White
CODE: 8562

SPECIAL

SILICONE

CALL YOUR REP FOR

**BULK
PRICING**



SILICONE ROOF & GUTTER GREY

300ML

- Bostik Quality
- Ideal for sealing sheet metal, roofing & gutter
- Potable water approved AS4020-1999
- Neutral Cure
- Non Corrosive
- Available as a box of 20

CODE: 9953

\$4.95

INC. GST



SILICONE ROOF & GUTTER TRANSLUCENT

300ML

- Bostik Quality
- Ideal for sealing sheet metal, roofing & gutter
- Potable water approved
- Neutral Cure
- Non Corrosive Confirms AS3718
- Available as a box of 20

CODE: 9926

\$4.95

INC. GST



SILICONE SANITARY GRADE TRANSLUCENT

300ML

- Available as a box of 20
- Sealing sinks and baths
- Neutral Cure
- Mould resistant

CODE: 9522

\$6.60

INC. GST



SILICONE SANITARY GRADE WHITE

300ML

- Available as a box of 20
- Sealing sinks and baths
- Neutral Cure
- Mould resistant

CODE: 9117

\$6.60

INC. GST

Valid until October 31st 2021

NEW!

WOMBAT



- Australian Designed
- Brass Shroud prevents spreading and splitting
- Tough NP3 compound which is heat resistant and hardwearing
- Passes 100,000 cycle test
- Complies with AS3718

10 Pack
Code: 8810

100 Pack
Code: 8811

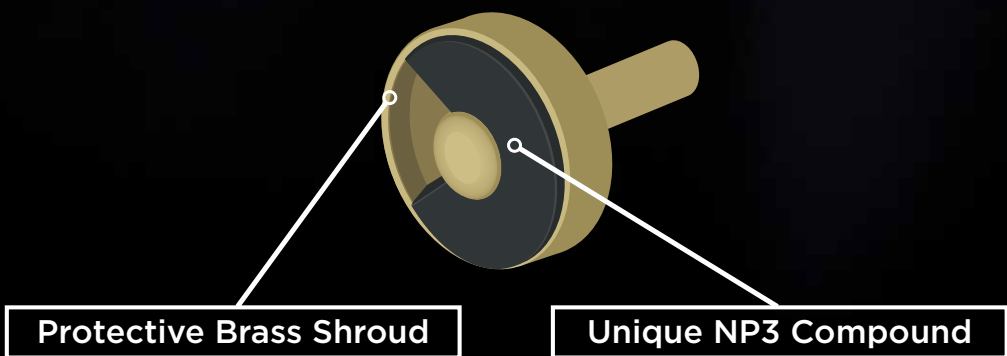

INTRODUCING THE **NEW** FLUIDMASTER PRO CISTERN

Most Powerful Flush System
Adjustable up to 9/4.5L PRO Cistern
with Link and Seat

INSTALL WITH CONFIDENCE

\$109¹⁰
INC. GST

Code: 2089

Includes
Low Level
Flush Pipe



4.5/3L Dual Flush Technology
Simple Flush Volume Conversion
to 6/3L or 9/4.5L
UV Resistant - Certified
Plastic Cistern with Bottom Inlet
Saves Water

EQUIPPED WITH FLUIDMASTER TECHNOLOGY



Fluidmaster Pro
Series Cistern
Inlet Valve



Fluidmaster
Universal Dual
Flush Outlet Valve



www.Fluidmaster.com.au



Toilet Seat Fixing

- Top/Blind fixing toilet seat anchor kit
- Easy to fit
- Includes stainless steel bolts and washers

\$3163
INC. GST
Code: 6169

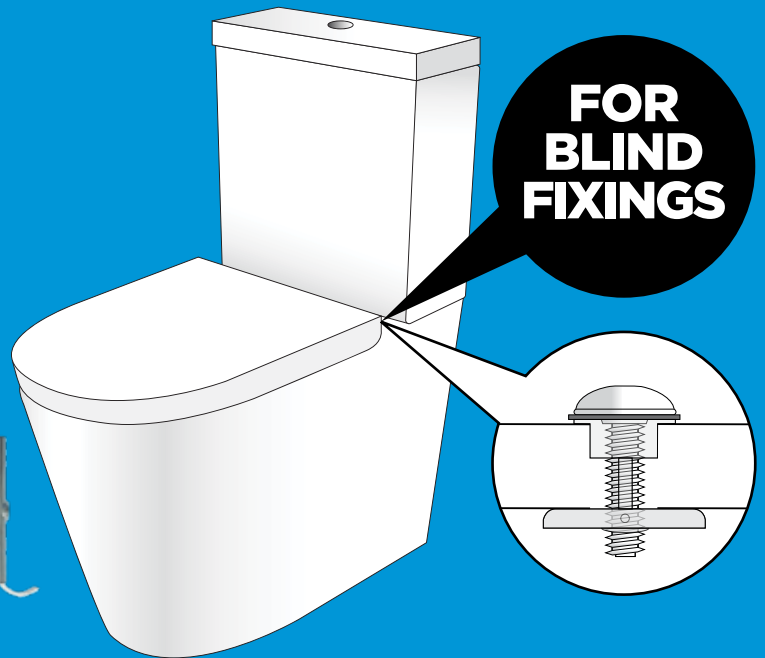
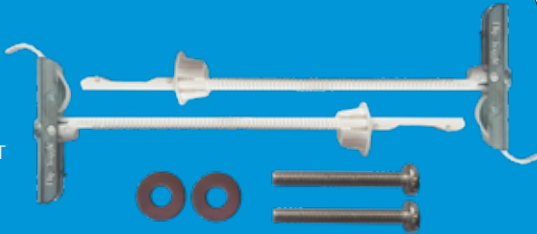

STEP 1
Align toggle with hole

STEP 2
Insert toggle into fixing hole in pan

STEP 3
Slide nylon bush down to hold toggle in position

STEP 4
Snap off the shaft leaving the flat of the bush exposed

STEP 5
Insert bolt & engage with toggle. Tighten



Wax Pan Seal

Repair leaky toilets without removing the pan

- Moulded to shape and ready to use
- Remains flexible
- Suitable for "S" or "P" trap pans

\$2461
INC. GST
Code: 1882

CHS CHRIS HUNTER SALES

Jacko's Review

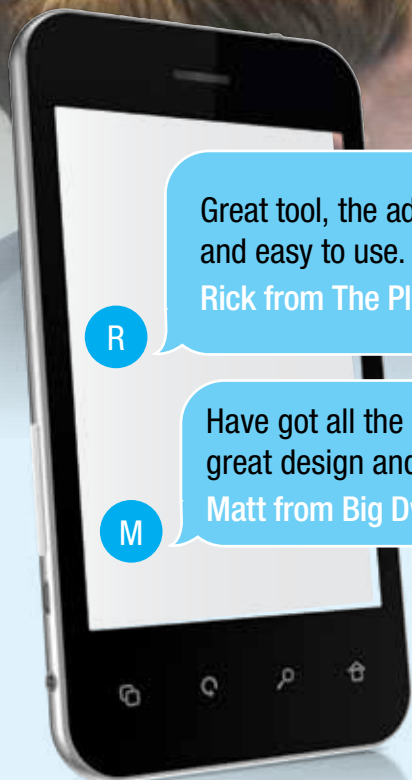

Great tool, the adjustable dial is precise and easy to use. A must for every drainer.
Rick from The Plumbing Cowboy

R

Have got all the lads using them, accurate, great design and well made product.
Matt from Big Dwarf Plumbing & Drainage

M

plumtool™

Level Gradient Adjustable

600mm



SPECIAL

\$165.00
INC. GST

Code: 2493

SAVE \$40.61

- Great drainers' tool
- Set dial to gradient required
- As used by plumbing inspectors
- Can also be used as a standard level
- Adjustable 600mm

NEW!

PATENTED

BAL RATED DRAINAGE VENT & FLASHING KIT

Kit includes:

- Steel vent and cowl
- BAL rated flashing to suit steel roof
- Steel to PVC insulated adaptor

BAL12.5
Black Flashing Kit

Code: **8876**



BAL29
Red Silicone Kit

Code: **8877**

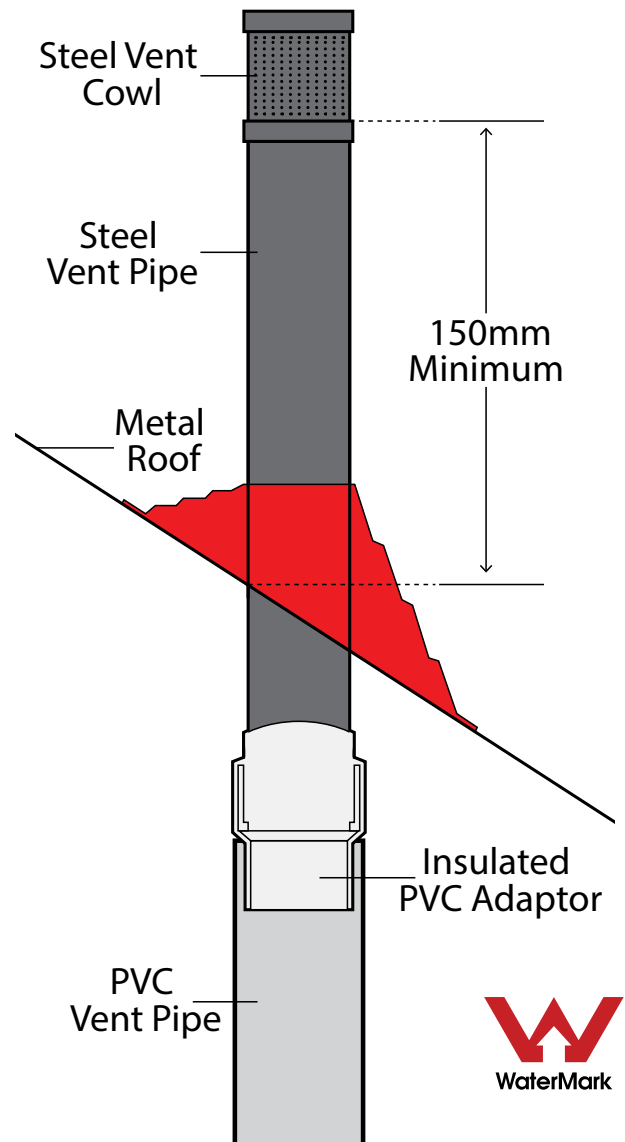

Drainla®

For use on pipework passing through concrete footings

DOES YOUR JOB COMPLY?



DONT GET CAUGHT OUT!

Drainlag complies with AS1345-1995 (Table 1) indicating that pipes containing sewerage and organic waste should be marked black.

Drainlag Black

- 100mm x 10 Metre Roll
- Closed Cell
- Non Absorbant
- Simple to apply to pipe and or fittings
- Complies with the following standards:

Code: 8720

AS3500 3.8.2 (b)

"Shall be installed with not less than 25mm annular space"

AS 1345-1995 (Table 1)

Colour Identification for Sewerage & Organic waste: Black

AS2870 5.5.4 (a)

"Closed cell polyethylene lagging shall be used around all drainage pipes through external footings"

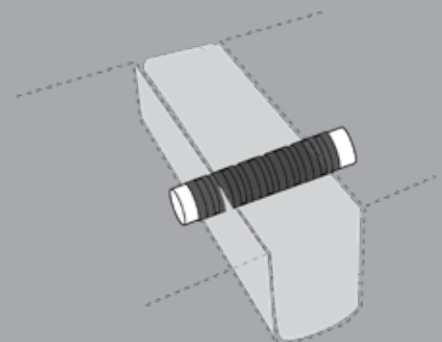
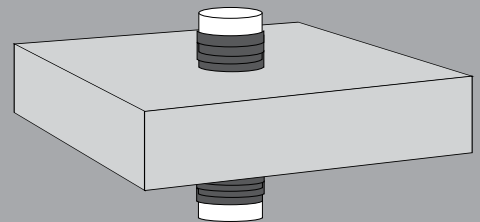

ECO
FRIENDLY
PACKAGING

CHS CHRIS HUNTER
SALES

MADE FROM
RECYCLED
MATERIALS

Pex Clips

DUALPEX

**WITH NYLON ANCHOR
MASONRY NAIL**

For 16-20mm Pex Pipe

\$35⁵⁹
INC. GST
Code: 7896

**BAG
100**

ALL IN
ONE CLIP
& PLUG



**SADDLE FOR PEX
WITH NYLON ANCHOR
MASONRY NAIL**

For 25mm Pex Pipe

\$21⁴²
INC. GST
Code: 7897

**BAG
50**

NEW



**DUAL
COPPER
SADDLE**

WITH MASONRY NAIL

For 1/2" & 3/4" Copper

- Removable insert to fit 3/4" tube
- Saves time and money by only having to stock one clip

PATENTED

\$39⁹³
INC. GST
Code: 9029

**BAG
100**

NEW

Remove
1/2" insert
to use on a
3/4" tube

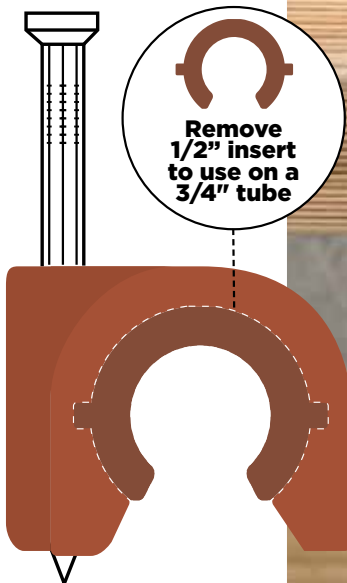

Quickie Kit



Connections to unit allow for height adjustment

Universal swivel fittings for sideways adjustment

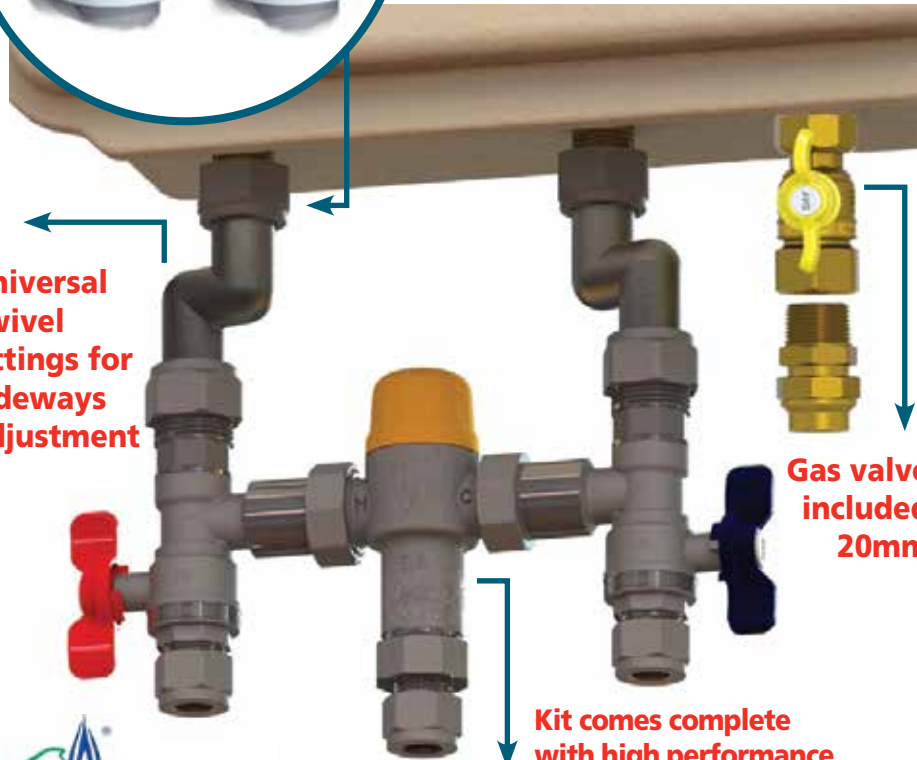

Gas valve included 20mm

Kit comes complete with high performance tempering valve



24 Month warranty



Insulation & cable ties provided to comply with AS3500

Fit-off a hot water service in minutes!
Suits all instantaneous hot water services.

15mm outlet & tempering valve Code: 8300 | 20mm outlet & tempering valve Code: 8301

Andrew from AMT Plumbing in Bayswater said:

I recently tried the Quickie Kit on an install. I reckon it saved me at least 30-45 minutes. The insulation and cable ties included in the kit made for a nice neat finish. Everything I needed was there.

Loose Nut Ball Valve Kit with Union

- Gas 20mm loose nut x 20mm female
- Water 20mm loose nut x 20mm female
- Outlet fitting 20Fi x 20C

Code: 8306

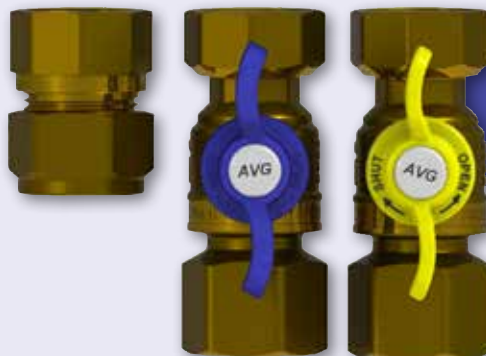

Instantaneous Continuous Flow Kit



LOOSE NUT DUO VALVES

- Watermark approved
- 100% pressure tested
- Integral non return and isolation function
- Suitable for horizontal and vertical installation



DUO VALVE **LOOSE NUT TO COPPER OLIVE 15mm**

- Working temperature -15°C to 90°C
- Maximum pressure rating 1600 KPa

Code: 6862



DUO VALVE **LOOSE NUT TO FI 15mm**

- Working temperature -15°C to 90°C
- Maximum pressure rating 1600 KPa

Code: 6861



DUO VALVE **LOOSE NUT TO COPPER PUSH FIT 15mm**

- Working temperature -15°C to 90°C
- Maximum pressure rating 1600 KPa

Code: 6863



DUO VALVE **LOOSE NUT TO PRESS 15mm**

- Working temperature -15°C to 90°C
- Maximum pressure rating 1600 KPa

Code: 6860

BULK SPECIAL

BUY ANY 10 MIXERS

SINK • BASIN • SHOWER



**BASIN MIXER
FIXED**

1500kPa
120mm Code: 2866

**BASIN MIXER
SWIVEL**

1500kPa
120mm Code: 2835

**SINK MIXER
SWIVEL**

1500kPa
225mm Code: 2830

SHOWER MIXER
1500kPa Code: 2865

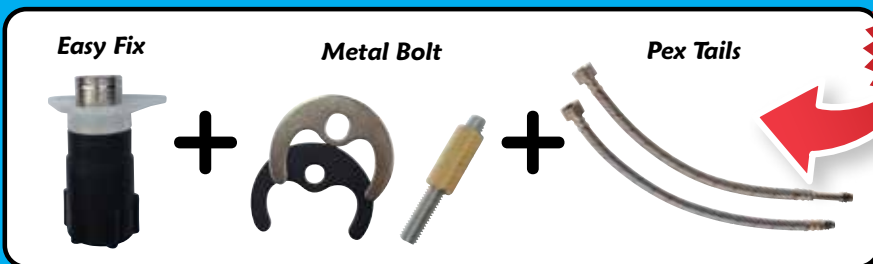

**BASIN &
SINK MIXERS
COME WITH**

**ONLY
\$693.00
INC. GST**



**GET A FREE
SLIMLINE WRENCH SET
WITH ANY 10 MIXER BULK PURCHASE
VALUED AT \$187.42**



Valid until October 31st 2021

STOP TAPS



STOP TAP MODULAR 1/4 TURN CERAMIC DISC

Individually tested & watermarked
Supplied with red & blue
indicator buttons
Quality ceramic disc
Conforms AS3718

Code: 6593



STOP TAP MODULAR 1/4 TURN CERAMIC DISC

Individually tested & watermarked
Supplied with red & blue
indicator buttons
Quality ceramic disc
Conforms AS3718

Code: 6594



STOP TAP MODULAR 1/4 TURN CERAMIC DISC

Individually tested & watermarked
Supplied with red & blue
indicator buttons
Quality ceramic disc
Conforms AS3718

Code: 6595



STOP TAP MINI

Traditional mini stop with jumper valve
Individually tested & watermarked
Tap washer is fixed to spindle to ensure
there is no water hammer
Conforms AS3718

Code: 6585



STOP TAP TRI VALVE 1/4 TURN CERAMIC DISC

Dishwasher installation made easy
Reduces the chance of leaks
Six fittings in one
Conforms AS3718

Code: 6245



STOP TAP DISHWASHER 1/4 TURN CERAMIC DISC

Individually tested & watermarked
Quality ceramic disc
Conforms AS3718

Code: 6586



STOP TAP 1/4 TURN CERAMIC DISC

Individually tested & watermarked
Quality ceramic disc
Conforms AS3718

Code: 6584



STOP TAP BLACK LEVER HANDLE 1/4 TURN

Matte black
Individually tested & watermarked
Quality ceramic disc

Code: 6591



STOP TAP LOOSE NUT

Fitquik swivel nut for ease of installation
Ceramic disc
Ideal for confined spaces
Proven spindle design, guaranteed
not to leak
Unique rubber cone makes
installation quick and simple

Code: 6587



STOP TAP LOOSE NUT WASHING MACHINE

Fitquik swivel nut for ease of installation
Ceramic Disc
Unique rubber cone makes
installation quick and simple
Conforms AS3718

Code: 6590

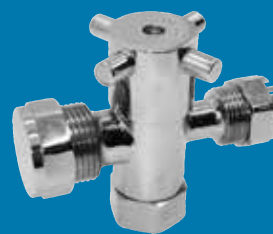

STOP TAP LOOSE NUT TRI VALVE

Connect tap & dishwasher
with single fitting
Ceramic Disc
Reduces the chance of leaks
Conforms AS3718

Code: 6251



STOP TAP LOOSE NUT TRI VALVE 15MM

Dishwasher installation made easy
Loose nut
Reduces the chance of leaks
Significant saving in time & money
Conforms AS3718

Code: 6592

STEEL STUDWORK?

plumbers choice

HAS THE ANSWERS!



34MM
AND
58MM



STEEL STUD DRILL

- Also great in roofing work for overflows, etc
- 34mm to suit yellow grommets
- 58mm for drainage vents

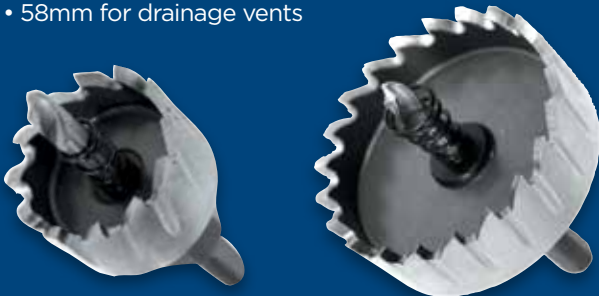

34mm

58mm

\$70⁵⁵
INC. GST
Code: 2000

\$152⁰⁹
INC. GST
Code: 2001



STUD CLIPS - WITH SD SCREW

- Works in any size hole

BAG
100

16MM
AND
20MM



16mm

20mm

\$29⁰⁸
INC. GST
Code: 5571

\$30⁸⁹
INC. GST
Code: 5572



\$599³⁷
INC. GST
Code: 1914

STUD PUNCH

- For the plumber in a hurry!
- Designed for cutting holes in steel stud work
- Cuts holes super fast



BAG 100

\$42⁷⁴
INC. GST
Code: 9241



MULTI-FIT GROMMET

Works in varying thicknesses of studwork (thickness 0.42mm to 2mm)
Complies to Australian Standards AS3500.1 12 Clause 5.5 2.2 Part C

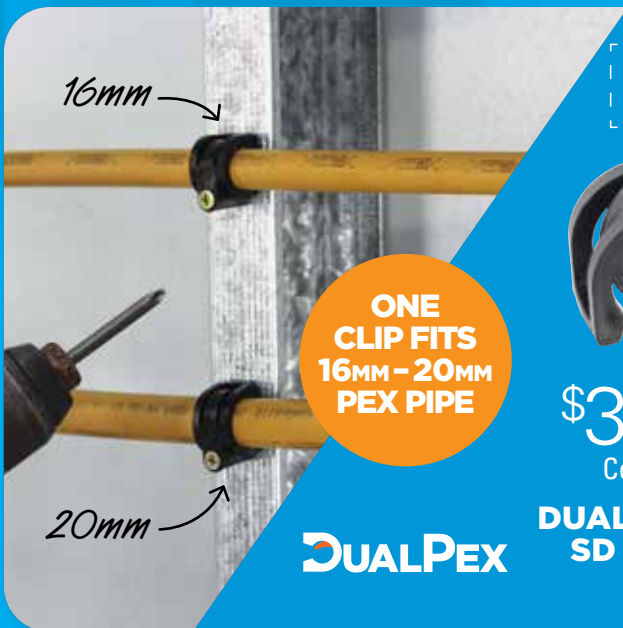

ONE CLIP FITS 16MM - 20MM PEX PIPE



BAG 100



\$33¹⁹
INC. GST
Code: 5558

DUALPEX CLIP SD SCREW

BAG 100



\$35⁵⁹
INC. GST
Code: 5575

DUALPEX CLIP SD SCREW WITH TAB

BAG 100



16mm
Code: 4526 **\$33.17**
20mm
Code: 4527 **\$36.71**

PEX SADDLES SD SCREW WITH TAB

PRELOADED

WITH HEX SD SCREWS
Code: 1471



330mm - 600mm

UNLOADED

Code: 1450



330mm - 600mm

MINI PRELOADED

WITH BUGLE SCREWS
Code: 1474



190mm - 330mm

FASTANOG

- Faster than timber noggins
- Compulsory in termite areas
- Set back measurer



preloaded
set back measurer

SLIDE TO ADJUST LENGTH



EXTENDO

GAS CONNECTOR

F + F NOW AVAILABLE



BROMIC
PLUMBING & GAS

Extendable
from **650mm**
to **1200mm**

- ✓ Saves Space, **ONE Connector does it all!**
- ✓ 12mm internal bore for better gas flow
- ✓ Flame resistant stainless steel
- ✓ AGA Approved 8633G
- ✓ 1/2" M+F
- ✓ 1/2" F+F

HANDY TIP:
Attach a brass tee to either end
to create a handle

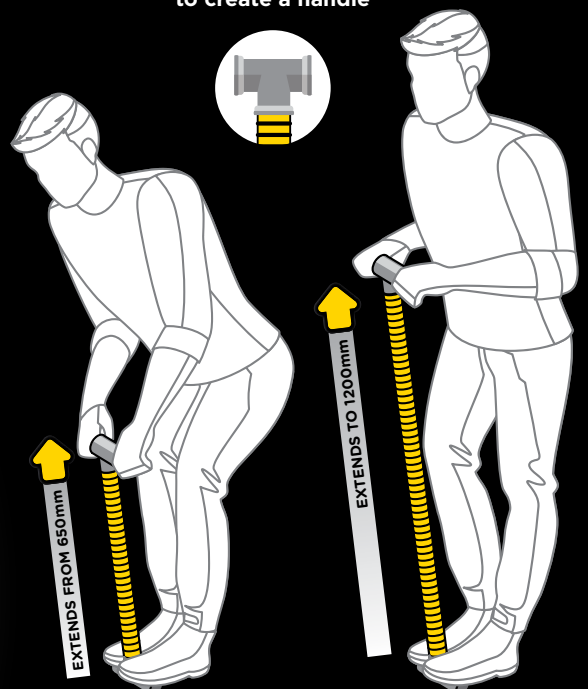

BOX
10

\$246.78
INC. GST

M+F Code: 6176
F+F Code: 6178

PLUG & WASTE

AVAILABLE NOW



PLUG & WASTE QUATTRO POP UP **4 in 1**

- Suitable for use on basins with or without overflow
- Suitable for 32 & 40mm outlets

32/40mm \$22.21 INC GST Code: 9005



PLUG & WASTE PLASTIC WITH S/S TRIM

40mm \$5.84 INC GST Code: 9024



WITH OVERFLOW

CHROME

PLUG & WASTE CHROME WITH OVERFLOW

32mm \$23.73 INC GST Code: 9022
40mm \$23.73 INC GST Code: 9020



CHROME

PLUG & WASTE CHROME

32mm \$23.73 INC GST Code: 9023
40mm \$23.73 INC GST Code: 9021

Plumbers' Bedding Compound

For a professional finish

MADE IN GERMANY

- Easier clean up than silicone
- Remains flexible
- Temperature range: -10°C to +100°C
- Made in Germany

\$22.26 INC. GST
Code: 1846



Applications:



Plug



Sink



Toilet

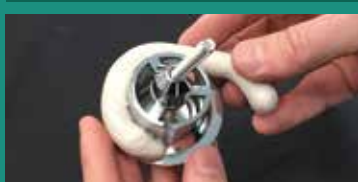

1. Roll out and place around plug and washer



2. Tighten plug and washer into place



3. Remove excess compound



4. Job completed

DISHWASHER COVER PLATES

"For the professional plumber"



BEFORE

AFTER

NEW

- Leave a neat finish in the cupboard
- Keeps pests out
- Fits over the solenoid valve

Code: 1792



Australia is currently experiencing a Mouse Plague

STOP



them in their tracks with a

**DISHWASHER
COVER PLATE**

SPECIFICALLY DESIGNED FOR CUTTING PVC



**30% MORE
EFFICIENT THAN
STANDARD BLADES**

**CUTS STRAIGHT
EVERYTIME**

**BATTERIES
LAST LONGER**

**CUT IS FREE
OF BURRS**



SAMURAI RECIPROCATING SAW BLADE PVC

• 210mm • 16TPI • Made in Japan

**AVAILABLE IN A
BOX of 10**

\$19⁵¹ EACH
INC. GST
Code: 9632

COPPER ROUNDING TOOL

NEW

3/4" \$55.⁶⁴
INC. GST

Code: 9898

Suitable for 3/4" copper tube

1/2" \$52.⁸⁸
INC. GST

Code: 9988

Suitable for 1/2" copper tube

- Saves time
- Nuts slide on easily
- Great frustration saver
- Lightweight and compact

**ROUNDS
OUT
COPPER IN
SECONDS!**

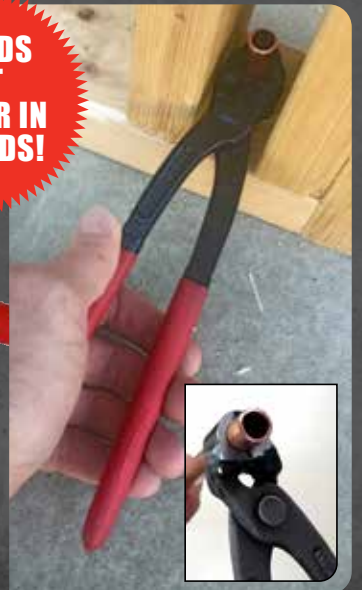

plumtool™

Innovative tools for **PLUMBERS**



CODE	ALUMINIUM - DESCRIPTION	PRICE
1524	Testing Plug Aluminium 40mm	\$42.04
1356	Testing Plug Aluminium 50mm	\$39.15
2289	Testing Plug Aluminium 65mm	\$45.38
9193	Testing Plug Aluminium 75mm	\$60.50
2283	Testing Plug Aluminium 150mm	\$74.70
8765	Plumtest Test Plug Aluminium 90mm	\$64.68
7268	Test Plug Aluminium 200mm	\$112.45
7269	Test Plug Aluminium 255mm	\$154.29
7274	Test Plug Aluminium 450mm	\$683.63

CODE	NYLON - DESCRIPTION	PRICE
7263	Test Plug Nylon 40mm	\$21.59
7262	Test Plug Nylon 50mm	\$25.76
7271	Test Plug Nylon 65mm	\$33.37
7270	Test Plug Nylon 75mm	\$34.54
7260	Test Plug Nylon 100mm	\$26.74
7265	Test Plug Nylon 150mm	\$45.34

INFLATABLE TEST PLUG 100MM

- Equipped with 2.5m hose
- To suit 100mm PVC
- Inflate with car pump
- Can be used down an inspection shaft

Code: 2009

\$105.67

Equipped with 2.5m hose

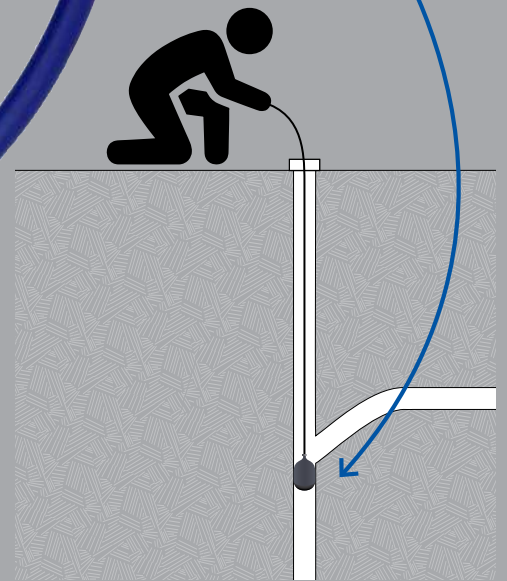
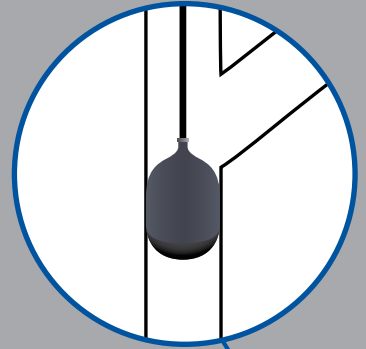

TEST PLUG ALUMINIUM 100MM

- A breeze to install
- 2 convenient tie-off points
- Size 100mm

Code: 2149

\$52.84



TEST PLUG RIGHT ANGLED WITH HANDLES 100mm

- Keeps hands out of the drain
- A breeze to install
- Cannot be lost down drain
- The only plug to use when testing at a right angled junction
- Cast Aluminium
- Patented

Code: 2004

\$153.16



SPILL SAFE



STOP THE SLOP



1

Tip entire contents into pan



2

Allow to set

3

Remove pan

- Turn the pan water to GEL
- No more water spills to clean up

\$7.55
INC. GST
Code: 2509

RED BACK



DRAIN DYE

NON TOXIC TO THE ENVIRONMENT

- Designed to trace waterflows in sewer & storm water drains
- 40g tub contains: 20g green & 20g red



1kg Red
\$232.76
INC. GST
Code: 9902

1kg Green
\$232.76
INC. GST
Code: 2511

40g tub
\$25.70
INC. GST
Code: 1947

RED BACK



YOU SPOKE, WE LISTENED!

To continue to make things easier for you to support Trade Only, we've made a few additions to www.plumberschoice.com.au



ORDER TEMPLATES



FAVOURITES



QUOTES

Save Order Templates

You can now save custom Order Templates.

With just one click, add all the items from your Order Template to your shopping cart. Perfect for fit off packs, hottie kits or end of month stock top ups.

Favourite Items

Access to your favourite and most used items on the one page.

No more scrolling through to add the same items you buy every order. Now add them all from the convenience of one page.

Request a Quote

Want some gear quoted?

Haven't had some items priced up by your Sales Rep yet? Well, from the cart page you can now order or request a quote on the gear in your shopping cart.

Don't have an online account yet?

Head to www.plumberschoice.com.au/register/ and sign up today. Order any time from the convenience of your phone or laptop.



TIP OF
THE
MONTH

We'll tip
YOU
when you tip
US!



Every featured story receives a
\$200 Store Credit

Use a squeezezy plastic sauce bottle to rinse out the shavings after re-seating a tap valve.



Thanks to Jeff Day,
\$200 store credit is coming your way

To get involved send us an email info@plumberschoice.com.au



PRESS GAS FITTINGS



PRESS GAS COUPLING

CODE	SIZE	PRICE
8639	15mm	\$6.26
8640	20mm	\$8.04
8641	25mm	\$13.75



PRESS GAS SLIP REPAIR COUPLING

CODE	SIZE	PRICE
8642	15mm	\$6.00
8643	20mm	\$7.54
8644	25mm	\$11.69



PRESS GAS ELBOW F/F 90°

CODE	SIZE	PRICE
8645	15mm x 90	\$7.44
8646	20mm x 90	\$9.72
8647	25mm x 90	\$17.86



PRESS GAS ELBOW F/F 45°

CODE	SIZE	PRICE
8648	20mm x 45	\$11.60
8649	25mm x 45	\$15.46



PRESS GAS REDUCING COUPLING F/F

CODE	SIZE	PRICE
8650	20mm x 15mm	\$11.11
8651	25mm x 20mm	\$13.70



PRESS GAS REDUCER M/F

CODE	SIZE	PRICE
8652	20mm x 15mm	\$9.71
8653	25mm x 20mm	\$13.12



PRESS GAS TEE

CODE	SIZE	PRICE
8654	15mm	\$8.59
8655	20mm	\$14.81
8656	25mm	\$23.15



PRESS GAS TEE REDUCING

CODE	SIZE	PRICE
8657	20 x 20 x 15	\$15.29
8658	25 x 25 x 15	\$23.52
8659	25 x 25 x 20	\$26.00



PRESS GAS END CAP

CODE	SIZE	PRICE
8660	15mm	\$8.10
8661	20mm	\$9.13
8662	25mm	\$16.08



PRESS GAS ELBOW LUGGED

CODE	SIZE	PRICE
8663	15mm x 15FI	\$18.40
8664	20mm x 20FI	\$20.12



BLOCKHEAD PRESS GAS ELBOW LUGGED (90MM)

CODE	SIZE	PRICE
8698	15mm x 15MI	\$18.40



PRESS GAS ADAPTOR MI

CODE	SIZE	PRICE
8666	15mm x 15MI	\$5.51
8667	20mm x 20MI	\$13.59
8668	25mm x 25MI	\$21.39



PRESS GAS ADAPTOR FI

CODE	SIZE	PRICE
8669	15mm x 15FI	\$7.44
8670	20mm x 20FI	\$11.32
8671	25mm x 25FI	\$15.43

25 YEAR WARRANTY*

Brasshards is proud to offer a 25 year warranty against defects and manufacturing faults in CuPress fittings (when installed in accordance with national, state and local plumbing codes by a licensed plumber). Issues arising from incorrect installation, misuse or environmental elements are not covered by this warranty. Please contact Brasshards for a copy of our full warranty document.

PRESS WATER FITTINGS



PRESS WATER COUPLING

CODE	SIZE	PRICE
8601	15mm	\$4.13
8602	20mm	\$6.13
8603	25mm	\$8.70



PRESS WATER SLIP REPAIR COUPLING

CODE	SIZE	PRICE
8604	15mm	\$4.68
8605	20mm	\$7.19
8606	25mm	\$10.52



PRESS WATER ELBOW F/F 90°

CODE	SIZE	PRICE
8607	15mm x 90	\$4.68
8608	20mm x 90	\$7.19
8609	25mm x 90	\$13.24



PRESS WATER ELBOW F/F 45°

CODE	SIZE	PRICE
8610	15mm x 45	\$5.86
8611	20mm x 45	\$8.08
8612	25mm x 45	\$14.87



PRESS WATER ELBOW M/F 90°

CODE	SIZE	PRICE
8681	15mm	\$5.41
8682	20mm	\$7.11



PRESS WATER REDUCING COUPLING F/F

CODE	SIZE	PRICE
8613	20mm x 15mm	\$9.38
8614	25mm x 20mm	\$15.99



PRESS WATER REDUCER M/F

CODE	SIZE	PRICE
8615	20mm x 15mm	\$8.41
8616	25mm x 20mm	\$11.94



PRESS WATER END CAP

CODE	SIZE	PRICE
8623	15mm	\$7.43
8624	20mm	\$9.00
8625	25mm	\$17.63



PRESS WATER TEE

CODE	SIZE	PRICE
8617	15mm	\$7.23
8618	20mm	\$10.89
8619	25mm	\$20.21



PRESS WATER TEE REDUCING

CODE	SIZE	PRICE
8620	20 x 20 x 15	\$13.51
8621	25 x 25 x 15	\$19.12
8622	25 x 25 x 20	\$22.96
8683	20 x 15 x 15	\$17.84
8684	20 x 15 x 20	\$18.77



PRESS WATER ELBOW LUGGED

CODE	SIZE	PRICE
8626	15mm x 15FI	\$13.36
8627	20mm x 20FI	\$19.05



BLOCKHEAD PRESS WATER ELBOW LUGGED (90MM)

CODE	SIZE	PRICE
8699	15mm x 15MI	\$16.35



PRESS WATER ELBOW FI

CODE	SIZE	PRICE
8629	15mm x 15FI	\$14.77
8630	20mm x 20FI	\$17.88



PRESS WATER ELBOW MI

CODE	SIZE	PRICE
8631	15mm x 15MI	\$14.23
8632	20mm x 20MI	\$17.89



PRESS WATER ELBOW UNION

CODE	SIZE	PRICE
8687	15mm x 1/2"	\$9.03
8688	20mm x 3/4"	\$13.64



PRESS WATER ADAPTOR MI

CODE	SIZE	PRICE
8633	15mm x 15MI	\$6.95
8680	15mm x 20MI	\$10.60
8634	20mm x 20MI	\$11.47
8635	25mm x 25MI	\$20.52



PRESS WATER ADAPTOR FI

CODE	SIZE	PRICE
8636	15mm x 15FI	\$6.59
8637	20mm x 20FI	\$8.41
8638	25mm x 25FI	\$14.99



PRESS UNION

CODE	SIZE	PRICE
8685	15mm Loose Nut x 15mm Press (Flat Seat)	\$11.61
8679	20mm Loose Nut x 20mm Press (Flat Seat)	\$11.75

- Flame-free
- Permanent V-Profile press join
- All fittings comply with Australian Standards AS3688



BIGGEST TIMBER SHORTAGE IN OVER 40 YEARS

SAVE A LOG BUY A **FASTANOG**

NEW

Same
price as a
traditional
luggie!

**BLOCK
HEAD**

BLOCKHEAD LUGGED ELBOW

- Reduce the number of noggins required
- Can press it while in place
- Fix it from any direction
- Lead-free brass
- 25 year warranty



Blockhead Press
Water Elbow Lugged
15mm x 15MI (90mm)
Code: 8699

Blockhead Press
Gas Elbow Lugged
15mm x 15MI (90mm)
Code: 8698



Traditional Fix
Plumber's Noggin



Stud Fix
Fix to side of studs



Existing Noggin
Fix to carpenter's noggin



| PLUMBING SUPPLIES SPECIALIST |



PATENTED

Under licence no. 2001

FASTANOG BLOCK

4x FASTER

- Pre-loaded with bugle screws
- Set back measurer
- Fits small spaces
- Strong and versatile

CODE: 1475

AVAILABLE IN A
BOX OF 10



FASTANOG

PRELOADED WITH HEX SD SCREW

Extends 330mm – 600mm



Drill

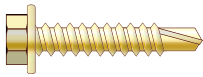

Hex SD Screw



CODE: 1471



PRELOADED WITH BUGLE SCREW

Extends 330mm – 600mm



Drill



Bugle Screw

CODE: 1464



MINI PRELOADED WITH BUGLE SCREW

Extends 190mm – 330mm



Drill



Bugle Screw

CODE: 1474



SAY GOODBYE TO TIMBER NOGGINS

PATENTED

MONUMENT PVC CUTTERS



QUICK & CLEAN CUT!



**PIPE CUTTER
AUTOCUT MONUMENT
50MM PVC**

\$53⁰²

INC. GST
Code: 2645



**PIPE CUTTER
AUTOCUT MONUMENT
40MM PVC**

\$49⁷²

INC. GST
Code: 2644

- Quality UK designed and made
- Quick and clean cut
- Light weight
- Ideal for confined spaces
- Spare blades available



PIPE CUTTER SPARE BLADES
For Monument PVC Autocutters Per 5

- Spare blade suits both 40 & 50mm cutters

\$17⁰⁵

INC. GST
Code: 2646

MONUMENT TOOLS